

Decision Support System for the Water Supply System in Fukuoka, Japan

Kawamura, Akira

Associate Professor, Institute of Environmental Systems, Kyushu University, Fukuoka, Japan

Jinno, Kenji

Professor, Institute of Environmental Systems, Kyushu University, Fukuoka, Japan

Merabtene, Tarek

Senior Research Engineer, CTI Engineering, Co., Ltd., Fukuoka, Japan

ABSTRACT: This study introduces an integrated decision support system (DSS) for the water supply system in Fukuoka City, Japan. The objective is to conceive a comprehensive tool that may aid decision-makers to derive the best water supply alternatives from a multi-reservoir system in order to minimize the long-term drought damages and threat of water shortage. The present DSS consists of a graphical user interface (GUI), a database manager, and mathematical models for runoff analysis, water demand forecasting, and reservoir operation. The methodology applied explicitly integrates the drought risk assessment, based on the concept of reliability, resiliency, and vulnerability, as constraints to derive the management operation. The application of the DSS to the existing water supply system in Fukuoka City was found to be an efficient tool to facilitate the examination of a sequence of water supply scenarios toward an improved performance of the actual water supply system during periods of drought.

1 INTRODUCTION

In recent years, drought management to maintain reliable water supply under various climatic and hydrological conditions has received increasing attention. Several methodologies have been proposed to assess the long-term adequacy of water supply systems and minimize the damages due to water deficit during periods of drought. Therefore, the concept of risk management has become widely accepted and applied in several studies. To mention only a few, Randall et al. (1990) discussed a multi-objective linear programming model to analyze the operation of a metropolitan water supply system. Their model includes a reliability criterion based on the minimum ratio of consumption to demand. Cancelliere et al. (1998) based on a linear relationship between water shortage and performance indices, investigated the susceptibility of a water supply reservoir to drought conditions for different demand patterns by using either a standard operating policy or hedging policies.

Recently, using so-called decision support system (DSS) is considered as the best way, if not the only, to deal with the increasing complexity of water supply systems (Simonovic and Bender, 1996). The notion of decision support systems (DSSs) for water resources planning and management was introduced more than a decade ago (e.g., Louks et al. (1985)). However, it is only in recent years that comprehensive DSSs have been developed and applied to real-world water supply systems and river basin management (e.g., Jamieson and Fedara (1996), Reistman (1996), Simonovic and Bender (1996)). Nevertheless, despite the increasing complexity of actual water supply systems, only few developed DSSs were concerned with drought and risk related aspects in water supply (e.g., Palmer and Holmes (1988)).

The present paper introduces a risk-based decision support system for operation of water supply systems. The objective is to develop a comprehensive DSS for simulating daily operational plans and assessing the performance of the water supply system for selected supply-demand alternatives. The DSS is applied to derive water supply alternatives, among a group of sources, that satisfy an acceptable "risk level" introduced to minimize the drought damages and threat of water shortage.

The current DSS consists of three main components, a user-friendly graphical user interface (GUI), a database manager, and mathematical models. The database manager was integrated to provide information on the water supply components, i.e., reservoirs, water heads and purification stations, and perform some fundamental time series analysis. The mathematical models are the mathematical base of the DSS incorporating (1) a rainfall-runoff analysis by tank model using the Kalman filtering technique to update model parameters, (2) a water demand forecast model, (3) a reservoir operation model, and (4) a drought risk assessment model. To evaluate the water supply alternatives from multi-sources water supply system, the methodology is based on a genetic algorithm (GA). The DSS systematically links, through a user-friendly GUI mainly written in Microsoft visual basic, the database manager for hydrological data to the mathematical models.

The developed DSS is applied to the optimal operation of water supply system in Fukuoka City, Japan, by conducting risk assessment for different water supply alternatives. The results demonstrate that the advantage of integrating DSS technique and risk analysis in the operation of complex water supply system is highly significant.

2 WATER RESOURCES SITUATION OF THE STUDY AREA

Fukuoka City is located in the northern part of Kyushu Island, Western Japan, at 33°E35'N north and 130°E24'N east. The city area is 338 km² and the population is 1.33 million as of October, 1999, which is the 8th largest city in Japan. Until now the population is increasing constantly. Fukuoka Metropolitan Area consists of Fukuoka City and 20 surrounding municipalities as shown in Fig. 1 (Kawamura and Jinno, 1996). The city has the geographical advantage of being close to the Korean Peninsula and the Chinese Continent and has therefore served as a gateway to import Asian continental cultures from ancient times. Fukuoka City has a mild weather with an annual average temperature of 16 Celsius and no severe earthquake or flood has ever been recorded. The annual average rainfall is about 1600 mm, only a fraction occurring as snow. Because of seasonal winds, there is both an early rainy season (June to July) and a typhoon season (September to October). The average rainfall from June to October constitutes around 60% of the annual average rainfall. The average evapotranspiration is about 960 mm/year (Kondo et al., 1992).

Since the time Fukuoka City started the water supply service in 1923, expansion projects have been carried out 18 times in order to cope with the rapid increase of water demand due to the concentration of population in urban areas, development of industries (urban infrastructure), the increase of living standard, etc. Nevertheless, the city is claimed very vulnerable to drought compared to other regions in Japan, because the area has a geographical disadvantage and

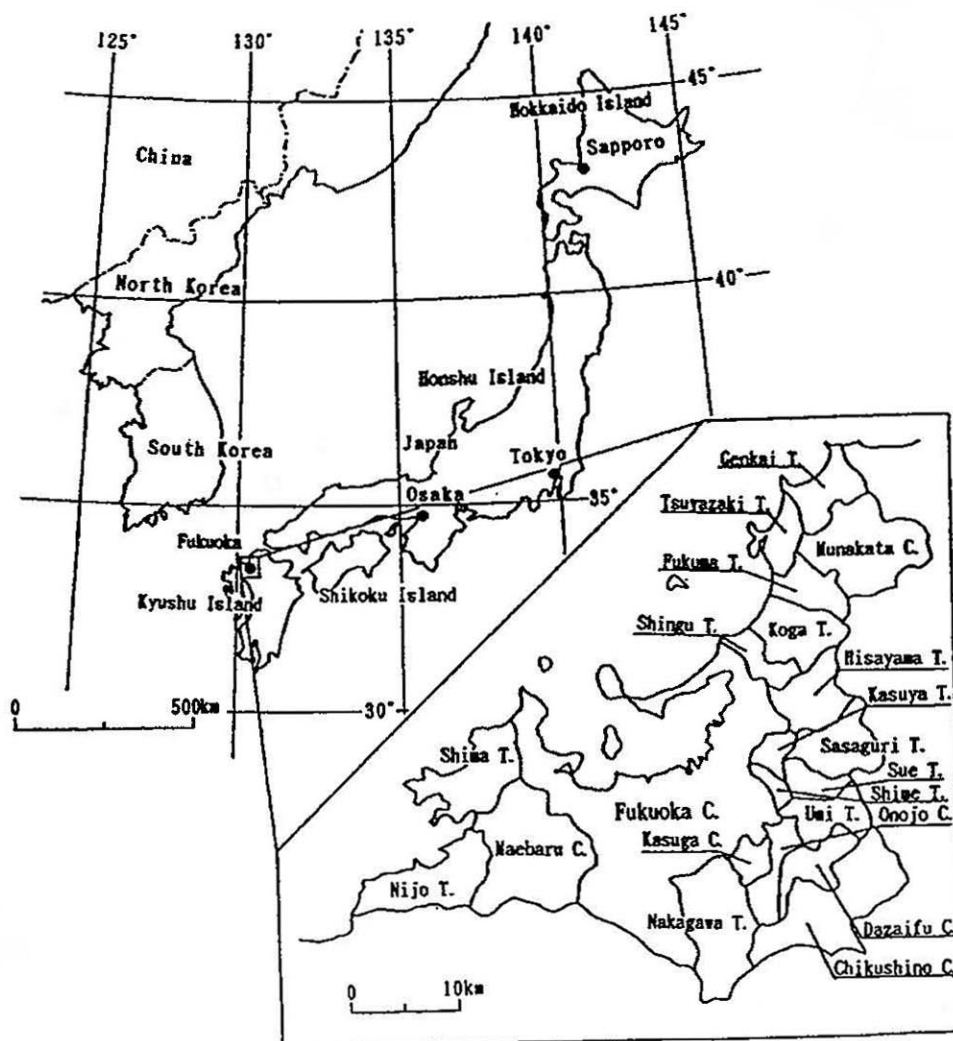

Fig. 1. Location of Fukuoka City and Fukuoka Metropolitan Area

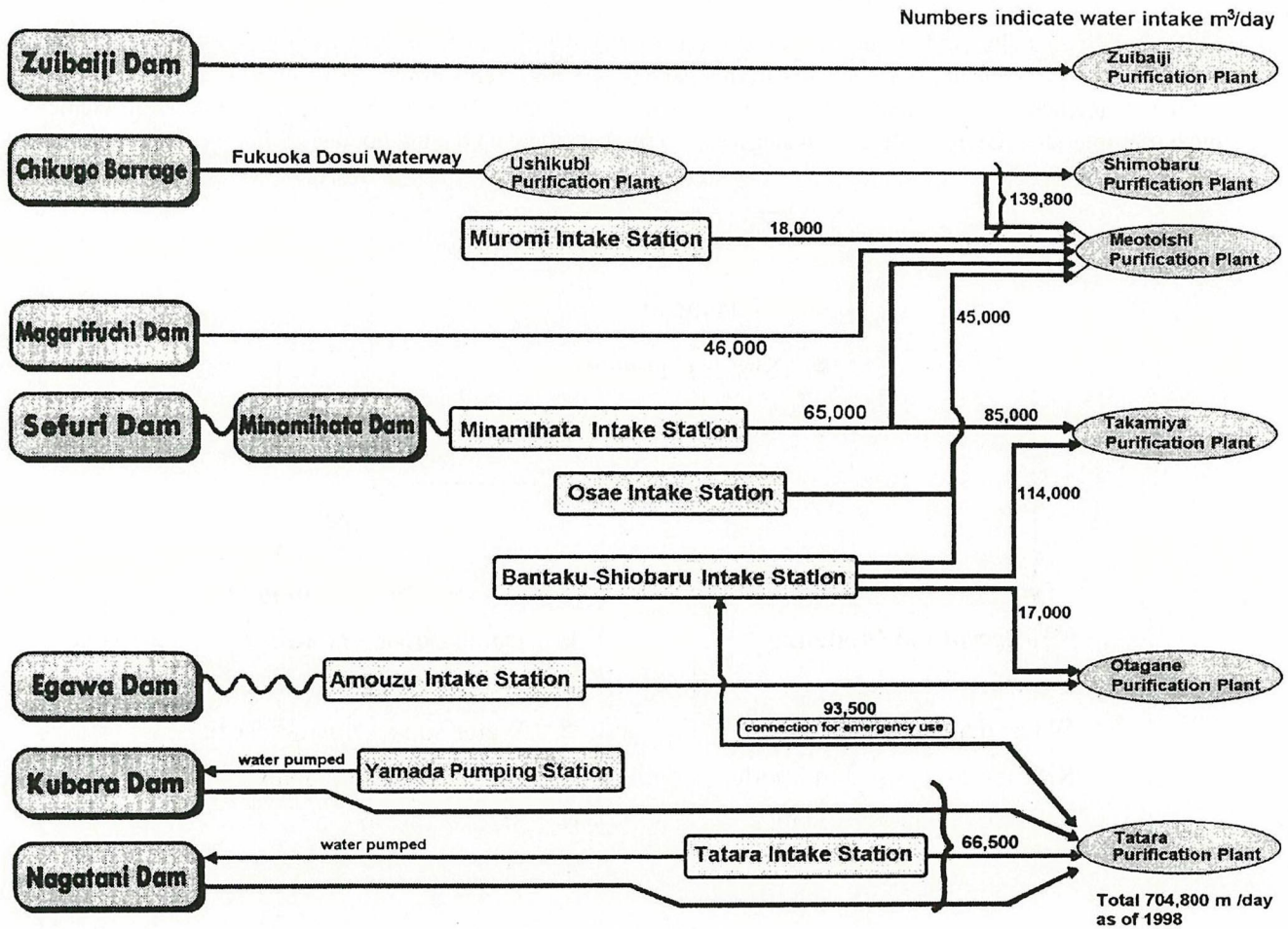

Fig. 2. Fukuoka City water supply network

water supply has to rely on several small rivers which flow through the city and very limited groundwater resources (1% of the total daily water supply) due to shallow aquifers, salt intrusion, and groundwater pollution caused by chlorinated hydrocarbons, as reported by Jinno et al. (1986). As the result, the city is always exposed to potential drought. In fact, the city was forced to water supply restrictions 11 times in the past. Especially, at the Fukuoka drought in 1978, water rationing lasted 287 days, and its drought index was 8,160 (%day), which is the worst drought record in Japan with 19-hour water supply cut per day at the worst days. Another severe drought struck the city again in 1994. In this drought event, the water rationing days recorded 295 days which are 8 days longer than 1978 drought, whereas its drought index 5,123 (%day) was much smaller compared with that of 1978 drought (Kawamura and Jinno, 1996). Now limited water resources are becoming one of the fundamental constraints for appropriate development of the area.

The major components of the present water supply system and waterworks facilities in Fukuoka City are illustrated in Fig.2 and include: (1) Five purification plants with a maximum water supply capacity of 704,800 m³/day; (2) direct water right from the Chikugo river basin yielding a maximum of 118,000 m³/day, which represents about one third of the total daily water supply. The Chikugo River basin belongs to a different jurisdiction, thus the water supplied to Fukuoka City is made under entitled agreement. Despite the importance of Chikugo River to ensure a stable water supply in Fukuoka City, significant reductions in yield can be expected during prolonged droughts of a duration longer than 1-1.5 year because of water share conflicts among users, stream flow depletion, and water quality deterioration as experienced during the past droughts; (3) Five water intake stations implemented on the surrounding small rivers with a maximum water supply capacity of 275,700 m³/day. The maximum water right from each station may vary monthly or seasonally; and (4) Seven dams with a total effective capacity of 45 million m³. The capacity directed to city, i.e., domestic, water supply is about 25 million m³ yielding a maximum of about 346,700 m³/day with high monthly water right variability. Despite the large capacity of the dam reservoirs, they are very vulnerable to drought due to their slow recovery (small catchment area and steep surface slope). Unusual climatic events, such as the droughts occurring in 1978 and 1994, cause the storage to decline to levels that require water use restriction.

3 DECISION SUPPORT SYSTEM

The DSS introduced in this study is an expanding model which attempts to comprise several aspects of water resources, water quality, and groundwater management. In this paper, the components of the DSS related to the first topic, water resources management, are presented and applied. As depicted in Fig. 3, the DSS integrates three main elements: a graphical user interface (GUI), a database manager, and a mathematical modeling module.

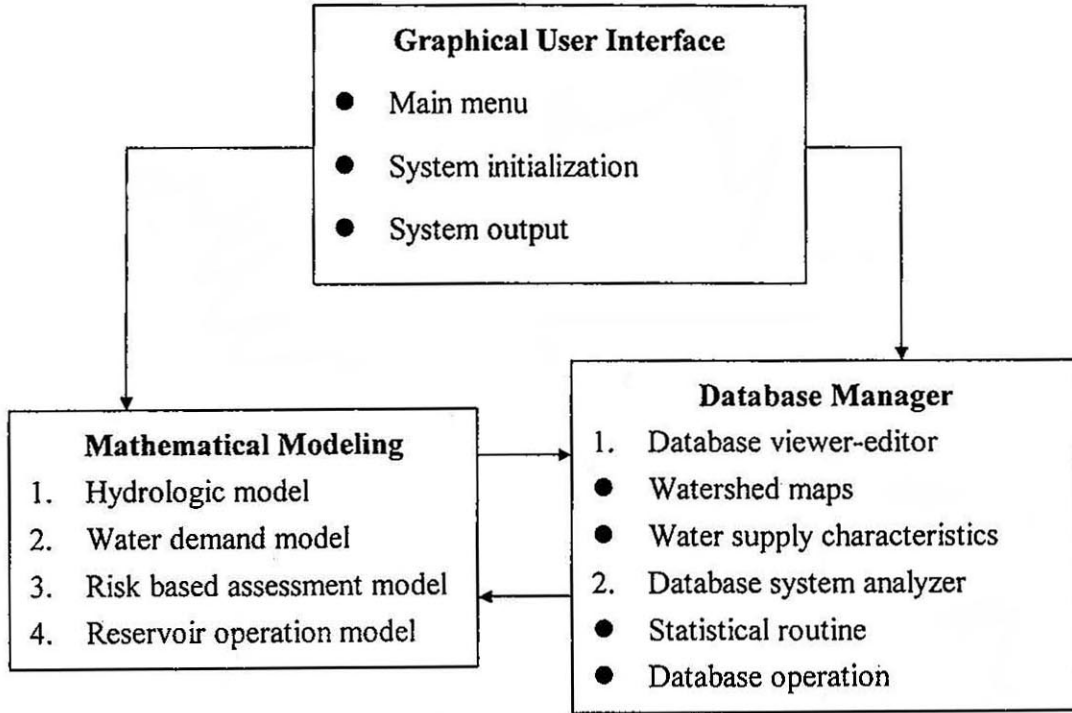

Fig. 3. Three main components of the proposed DSS

3.1 Graphical user interface

Interactivity and graphical presentation is an important issue in DSS development. The design of the interface has a great impact on the user's ability to assimilate information from the DSS and optimize the use of available functions. Therefore, the developed DSS is designed to be fully interactive and user-friendly. The interaction with the user and presentation of information take place through a graphical user interface (GUI). As shown in Fig. 4, all DSS components may be invoked from the main menu of the DSS software. The DSS environment was developed under Windows 95/NT and requires 13 MB of free hard-disk space. The GUI is written in Microsoft Visual Basic with a few modules in Microsoft Visual C++, particularly the GA components. Fig.5 shows an example of the DSS multi-windows framework in which database manager and mathematical models are invoked.

3.2 Database manager

Data quality and data handling are fundamental in all successful applications of any mathematical model, particularly in the calibration and validation stage preceding the actual application. This calibration stage and the associated manipulation of suitable data require much time and experience that may not be available during emergency actions. Therefore, the database manager is designed to be interactively integrated with the rest of the DSS components, and plays the role of a data communication network. Through the database manager the user may perform routine statistical analysis, aggregate the data for different time increments, select data corresponding to a certain event or season, plot and tabulate them, etc. (Merabtene et al., 1998a). All spatial data can be plotted as two-dimensional maps. Summary statistics for any location and functional component (reservoir, river basin, and water purification station) can be viewed by clicking on the appropriate location on the map. Moreover, the database manager permits data exchange (input/output) with software operating within a Microsoft Windows environment, such as Microsoft Excel and Microsoft Access, for subsequent data processing.

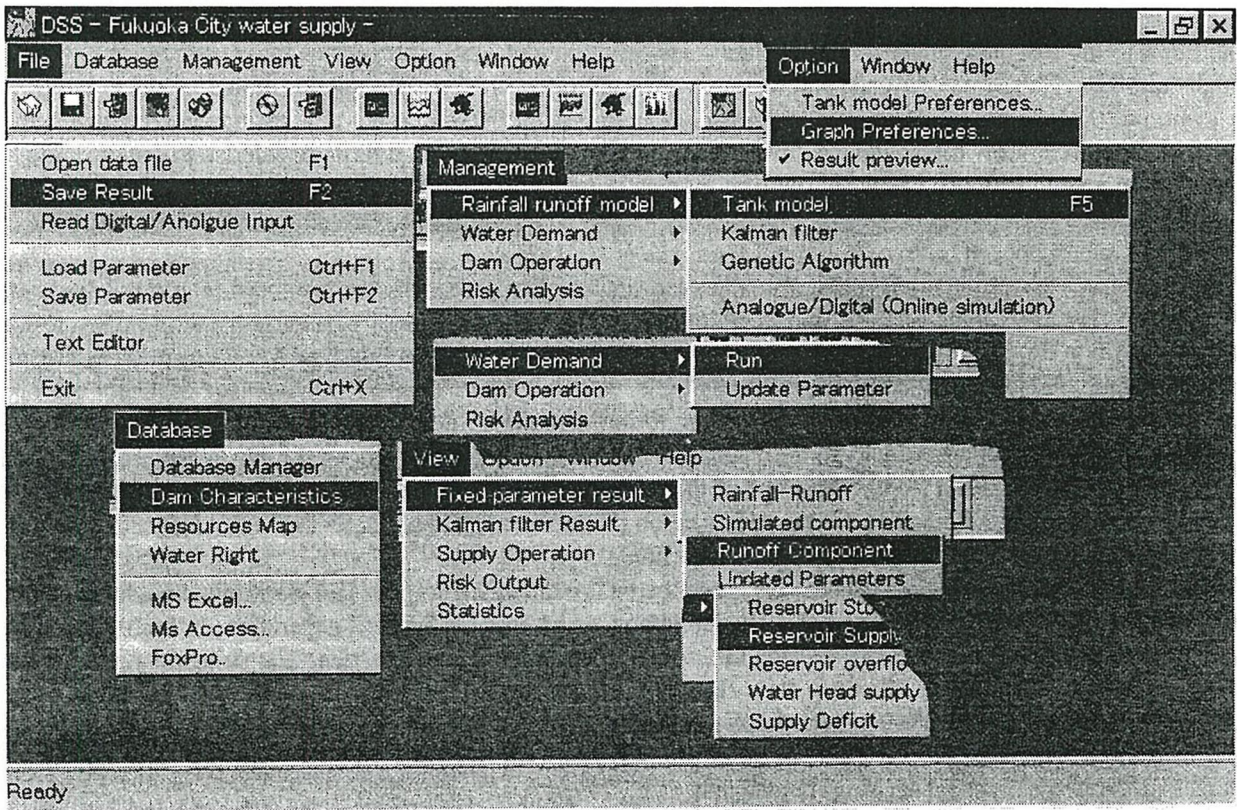

Fig. 4. The main menu of the DSS

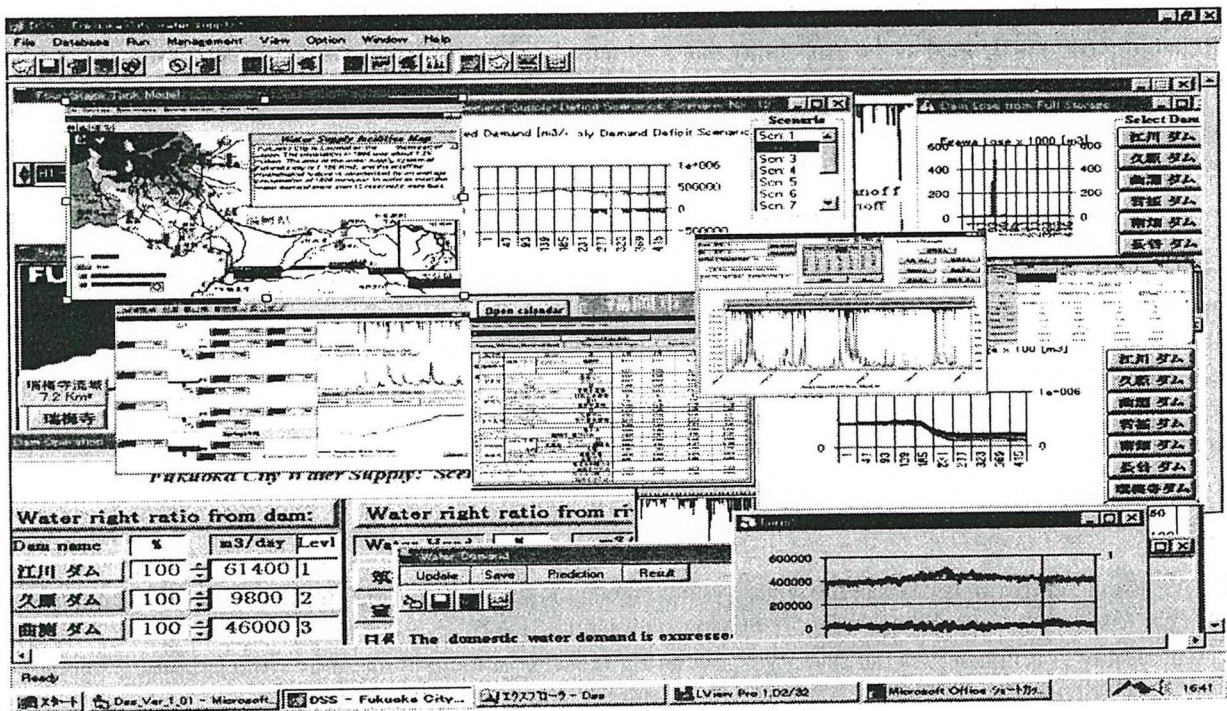

Fig. 5. An example of the DSS multi-windows framework

3.3 Mathematical models

In addition to the risk assessment model discussed later, the present DSS incorporates three mathematical models for rainfall-runoff analysis, water demand forecasting, and reservoir operation. The rainfall-runoff model is based on the application of the tank model (Sugawara (1974), Merabtene et al. (1997)). In order to alleviate the problems associated with imperfect streamflow prediction the developed model integrates Kalman filtering technique to optimize the model parameters in adaptive mode. The water demand model considers only the forecasting of daily domestic demand. The temporal variation of the water demand is expressed by a straightforward linear regression model expressing weekly and yearly cycles superimposed on an overall trend (Zongxue et al. (1998)).

In the reservoir operation model both simulation and optimization procedures are proposed. The simulation model is based on the risk assessment analysis and performance of the system to modify of the operation policy toward an improved solution. In other words, the system operation and control actions are derived to minimize drought damages and consequently reduce the shortage threats during the operation horizon. Despite the advantage of the model to define most appropriate water supply alternatives according to the risk output, it should be noticed that the performance the system may exhibit a strong sensitivity to the changes in the release distribution among the existing sources. Thereafter a non-optimal release operation from at least one of the reservoirs will undoubtedly lead to the deterioration of the entire system performance. In the present DSS the optimization procedure applied to derive the best water take policy from a multi-reservoir supply system is based on genetic algorithm (GA).

In the GA scheme, two distinct features are introduced: (1) a drought risk index (Eq. 4) as objective function, and (2) a qualification of selected strings, i.e., water take solutions, as parents for the next generation. In each generation, the drought risk index (*DRI*) is evaluated for each GA solution, i.e., water take allocation. The strings qualified as parents for the next generation are those being in the risk-based solution space, defined by the risk thresholds. There are two reasons for selecting only the chromosomes, i.e., water take solutions, from the risk-based solution space: (1) speed-up of the convergence process, (2) generation of future chromosomes which cluster within the defined acceptable risk level leading to appropriate practical decisions (Merabtene et al. (1998b)).

4 RISK ASSESSMENT MODEL

A number of indicators can be used to describe the performance of a water resources system. In the present DSS, the performance of a multi-sources system under drought conditions is evaluated by means of four indices: reliability, resiliency, vulnerability, and drought risk index (*DRI*) (Hashimoto et al.(1982) and Jinno et al.(1995))

Reliability (*Rel*) is defined as the probability that a system remains in a satisfactory state. It is estimated as the ratio of the number of satisfactory state intervals to the total time interval (*T*) of the operational period. It is expressed as:

$$Rel = \frac{1}{T} \sum_{t=1}^T SS_t \quad (1)$$

where *SS_t* is the state variable of the water supply system. *SS_t* equals 1 if no deficit occurs in the day *t*, and 0 if deficit occurs. Risk of failure may be expressed as *1-Rel*.

Resiliency (*Res*) is used to describe the ability of the system to recover from failure to an acceptable state. It is measured as the inverse of the average period of water deficit:

$$Res = \frac{1}{\frac{1}{NF} \sum_{i=1}^{NF} FS_i} \quad (2)$$

where *NF* is the number of times that the water system enters a failure state during the operation period, and *FS_i* the *i*th failure day. Risk of non-recovery from failure may be expressed as *1-Res*.

Vulnerability (*Vul*) quantifies the severity of occurring failures. In the present study, vulnerability is defined as the average deficit divided by the average water demand during the whole water supply period:

$$Vul = \frac{\sum_{t=1}^T Wd_t - WDS_t}{\sum_{t=1}^T Wd_t} \quad (3)$$

where *Wd_t* is the daily water demand, and *WDS_t* the daily water supply available at time *t*.

The three risk indices (risk of failure, risk of non-recovery from failure, and vulnerability) may be summarized in the drought risk index (*DRI*) defined by the linearly weighted function:

$$DRI = w_1 (I-Rel) + w_2 (I-Res) + w_3 Vul \quad (4)$$

where $w_1 + w_2 + w_3 = 1$.

In Eq. (4), w_1 , w_2 , and w_3 specify the relative weights of the respective risk criteria. In the simplest case, all weights may be assumed to be equal.

The four risk indices *I-Rel*, *I-Res*, *Vul*, and *DRI* are used by the reservoir operation model to evaluate the performance of the water supply system and assess the simulated water supply scenarios. Thus, in order to determine whether a derived water take scenarios is acceptable from the point of drought damages, maximum acceptable “risk levels” are defined:

$$I-Rel \leq (I-Rel)_{max} \quad (5)$$

$$I-Res \leq (I-Res)_{max} \quad (6)$$

$$Vul \leq Vul_{max} \quad (7)$$

The drought risk index threshold may be then formulated as:

$$DRI_{max} = w_1 (I-Rel)_{max} + w_2 (I-Res)_{max} + w_3 Vul_{max} \quad (8)$$

The risk levels may be visualized as a three-axis “solution space” where the axes represents the three risk indices (Fig. 6).

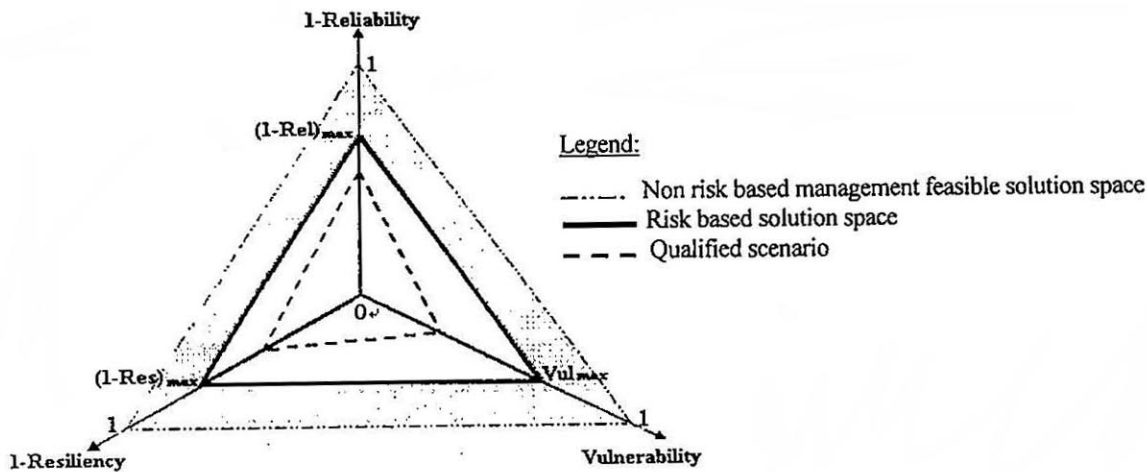

Fig. 6. Solution space of risk based management operation

In Fig. 6 the total feasible space ($0 \leq I-Rel \leq 1$, $0 \leq I-Res \leq 1$, and $0 \leq Vul \leq 1$) includes all feasible solutions. In term of risk management, the qualified scenarios are all solutions with risk values smaller than or equal to the risk thresholds defined by $(I-Rel)_{max}$, $(I-Res)_{max}$, and Vul_{max} as shown by the solid line in Fig. 6. On the other hand, solutions with risk values falling within the shaded space are likely to lead to long-term drought damages. In practice, the acceptable risk levels (Eqs. (5) to (8)) should not only include the criteria and preferences of the water officials (i.e., decision-makers) but also those of the public (i.e., consumers) in the planning and assessment of the water supply system reliability. Although it is clear that the public has limited experience with drought damages and water shortage, studies should be conducted to extract the necessary information on the risk accepted by the society, particularly in areas where water shortage has been severe. Thus, an investigation among consumers may be undertaken to define the acceptable water shortage magnitude (severity and duration) which may then be converted into an acceptable risk level.

5 DSS APPLICATION

To derive a water take policy from different sources using the present DSS, the user starts by selecting the operation period using the database manager. For forecast operation, the user is requested to input the starting and ending dates of the forecast period. The runoff to each reservoir in the water resources system is then evaluated. The domestic water demand is estimated next. The industrial and irrigation demands are assumed to be given for the operation period and retrieved to the system through the database manager. The reservoir operation model is then applied by introducing the management and planning preferences, e.g., acceptable risk thresholds, initial water take properties from sources, (i.e., initial water take order among sources), and maximum number of trials. The output of the DSS is the state of the water take sources and system performance for all qualified scenarios, i.e., scenarios that satisfy the acceptable risk level within the maximum number of trials.

In the following results, the susceptibility of Fukuoka City water supply system when subjected to water supply restrictions from the Chikugo River subsystem under different weather conditions was simulated. Two sets of climatological conditions were considered. The first was that of 1992, particularly characterized by drought in the Chikugo river basin, but not in Fukuoka City, and the second set of conditions is that of the 1994 drought. The drought risks for 1992 and 1994 were evaluated for the same water take allocation pattern from the local subsystem in Fukuoka City. Moreover, unlike the actual water supply state during the two periods, in the analysis it is assumed that the full water right from surrounding rivers could be supplied.

Fig.7 shows the variation of the performance of the entire water supply system for different percentages of maximum yield from the Chikugo River basin. The result shows that under normal weather conditions in Fukuoka City (as in 1992 with 1435 mm/year of precipitation), 20% of the maximum water right allocated to Fukuoka City from the Chikugo River is sufficient to satisfy the domestic water supply without need for water rationing. The result shows that if no water was supplied from the Chikugo River during the 1992 the operating period the risk of non-recovery of the system ($I-Res$) is 0.22 for a vulnerability Vul approximately equal to 0.01. The frequency of failure is still very low for this particular case with $I-Rel$ equal 0.05. By increasing the water supply from the Chikugo River, the total risk defined by the drought risk index (DRI) gradually decreases from 0.1, if no water for the Chikugo River is supplied, to 0 for 20% yield of the maximum water right allocated to Fukuoka City.

The result for the 1994 drought conditions, Fig.7 shows that if no water is supplied from the Chikugo River, the

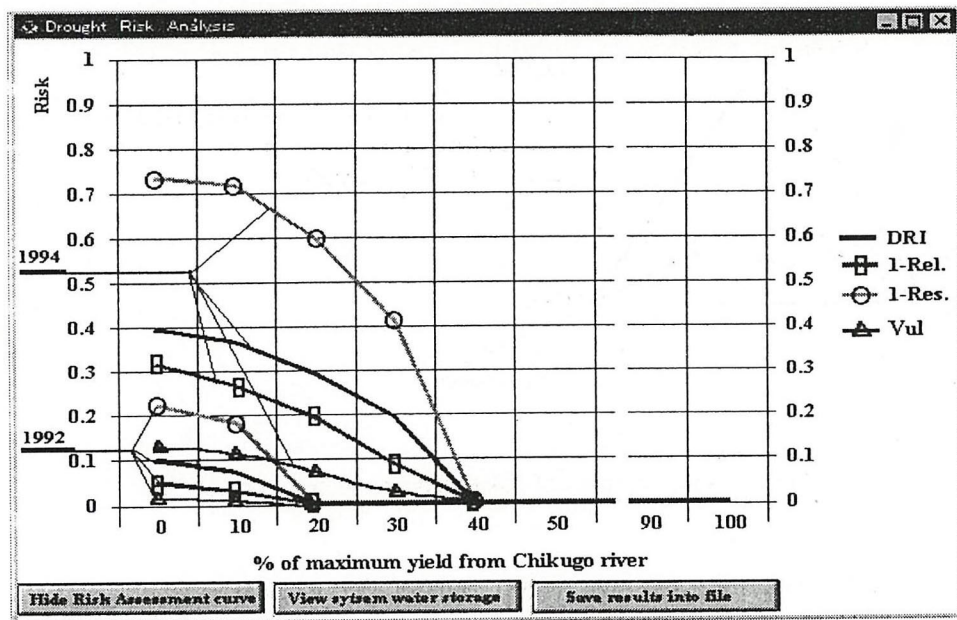

Fig. 7. Performance of Fukuoka City water supply system function of the change in daily water supply from the Chikugo River basin for both, 1992 and 1994 hydrologic conditions

system exhibit a high risk of non-recovery with $I-Res$ exceeding 0.7 with a vulnerability approximating 0.12 compared to 0.01 for the 1992 conditions. For this particular scenario (i.e., no water supply from the Chikugo River) the risk of failure of the system is about $I-Rel=0.31$. Therefore, even under the circumstance that 100% of the water right from the surrounding rivers could be supplied during the 1994 drought, the entire system exhibits a strong dependency on the

water supply from the Chikugo River subsystem. This conclusion is also justified by comparing the results of the total risk between the two hydrologic periods. As can be seen from Fig.7, the drought risk index for the 1994 drought scenarios is 4 times higher ($DRI = 0.4$) compared to the 1992 drought scenarios ($DRI=0.1$).

In the GA application, to alleviate the mathematical representation of the system the water supply from the Chikugo River basin and surrounding small rivers were assumed equal to the observed values during the selected drought operation period extending from January 1, 1994 to May 31, 1995. Fig.8 shows the variation of the risk indices, i.e., ($I-Rel$), ($I-Res$), Vul and DRI , at the end of the selected operation period as a function of the number of generations. The result shows that the water supply risks present slight improvements as the number of generation increases, and further more provides an improved practical water supply operation of less risk compared to the actual operation in 1994.

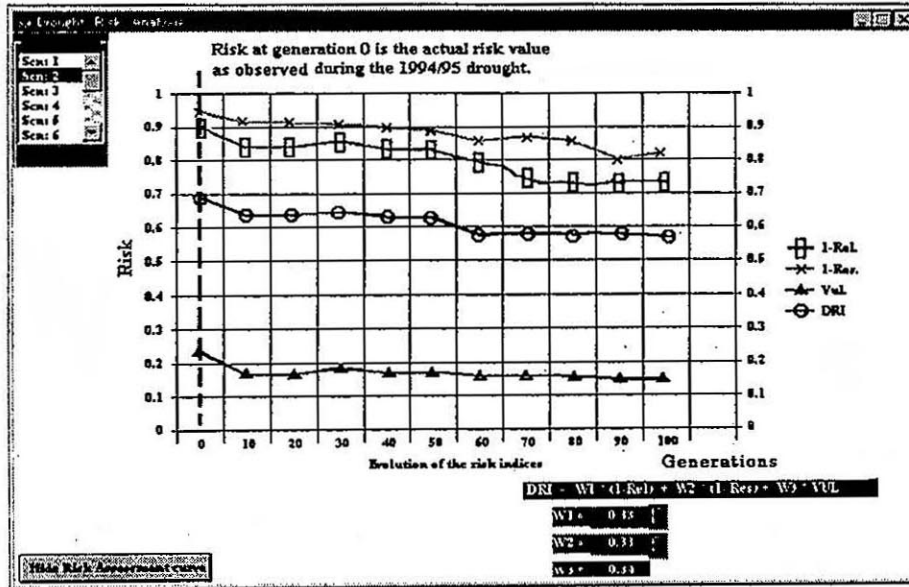

Fig. 8. Variation of the risk indices by GA as a function of the number of generation at the end of the operation period extending from January 1, 1994 to May 31,1995

6. CONCLUSIONS AND FUTURE DEVELOPMENT

A decision support system (DSS) for the water supply system in Fukuoka City was presented. The DSS was found efficient tool facilitating examination of sequences of scenarios as well as interpretation of the results faster and more accurately than traditional methods allow. It provides a database manager and a number of mathematical modeling frameworks involving tools for simulation and optimization. The application of the DSS reached a very encouraging results to improve drought management operation and to effectively reduce the risk of water deficit. The present DSS is intended to be further improved, and possible future developments include the following: (1) a knowledge-based expert system for incorporating experiences and judgment in the management of the water supply system during periods of drought, (2) By law, the waterworks in each municipality in Japan have to be operated on a self-paying basis, so that each municipality has to set its own water rate to compensate the water development and management costs. Thus, the possibility to include cost information is being considered.

7. REFERENCES

- Cancelliere, A., Ancarani, A., and Rossi G. (1998). " Susceptibility of water supply reservoir to drought conditions. " *J. Hydrol. Eng.*, Vol. 3, No. 2, pp. 140-148.
- Hashimoto, T., Stedinger, J. R., and Loucks, D.P. (1982). "Reliability, resiliency, vulnerability criteria for water resources system performance evaluation. " *Water Resour. Res.*, Vol. 18, No. 1, pp. 2917-2924.
- Jamieson, D.G., and Fedra, K. (1996). "The 'WaterWare' decision support system for river-basin planing. 1. Conceptual design" *J. Hydrol.*, No. 177, pp. 163-175.
- Jinno, K., Ueda, T., Oishi, H., Tsukamoto, K. and Yasuda, H. (1986). "Analytical approach to monitoring pollution by

- chlorinated solvents" *Monitoring to Detect Changes in Water Quality Series.*, IAHS Publ, No.157, pp. 185-196.
- Jinno, K., Zongxue, X., Kawamura, A., and Tajiri, K. (1995). "Risk assessment of water supply system during drought" *Water Res. Devel.*, Vol. 11, No. 2, pp. 185-204.
- Kawamura A. and Jinno, K. (1996). "Integrated water resources management in Fukuoka Metropolitan Area" *Environmental Research Forum*, No. 3&4, pp.97-109.
- Kondo, J., Nakazono, M., Watanabe, T., and Kuwagata, T. (1992). "Hydrological climate in Japan (3)- Evapotranspiration from forest" *J. Japan Soc. of Hydrol. Water Res.*, Vol. 5, No. 4, pp. 8-18, (in Japanese).
- Louks D.P., Kindler J., and Fedra K. (1985). "Interactive water resources modeling and model use: An overview" *Water Resour. Res.*, Vol. 21, No. 2, pp. 95-102.
- Merabtene, T., Jinno, K., Kawamura, A., and Matsunaga, T. (1997). "Interactive user interface for rainfall-runoff analysis by tank model" *Memoirs of the Faculty of Engineering, Kyushu University*, Vol. 57, No. 3, pp. 107-120.
- Merabtene, T., Jinno, K., Kawamura, A. and Olsson, J. (1998a). "Drought management of water supply systems: a decision support system approach" *Memoirs of the Faculty of Engineering, Kyushu University*, Vol. 58, No. 4, pp.183-197.
- Merabtene T., Jinno, K. and Kawamura, A. (1998b). "Development of a risk assessment decision support system for optimal control of water supply systems" *Proc. of Award-Winning Papers of International Water Supply Symposium in Tokyo '98*, pp.105-112.
- Palmer, R.N., and Holmes, K.J. (1988). "Operational guidance during droughts: Expert system approach" *J. of Water Resour. Plann. and Manag.*, ASCE, Vol. 114, No. 6, pp. 647-666.
- Randall, D., Houck, M.H., and Wright, J.R. (1990). "Drought management of existing water supply system" *J. of Water Resour. Plann. and Manag.*, Vol. 116, No. 1, pp. 1-20.
- Reistman, R.F. (1996). "Structure and support of water-resources management and decision-making" *J. Hydrol.*, No. 177, pp. 253-268.
- Simonovic, S.P., and Bender, M.J. (1996). "Collaborative planning-support system: an approach for determining evaluation criteria" *J. Hydrol.*, No. 177, pp. 237-251.
- Sugawara, M. (1972). "Runoff analysis" *Kyoritsu Publishing Company.*, (in Japanese).
- Zongxue, X., Jinno, K., Kawamura, A., Takesaki, S., and Ito, K. (1998). "Performance risk analysis for Fukuoka water supply system" *J. Water Resour. Manag.*, No.12, pp. 13-30.