

# ARROW SYMBOLS: THEORY FOR INTERPRETATION

By

Yohei Kurata

B.Eng. University of Tokyo, Japan, 2000

M.Eng. University of Tokyo, Japan, 2002

A THESIS

Submitted in Partial Fulfillment of the

Requirements for the Degree of

Doctor of Philosophy

(in Spatial Information Science and Engineering)

The Graduate School

The University of Maine

May, 2007

Advisory Committee:

Max. J. Egenhofer, Professor in Spatial Information Science and Engineering, Advisor

M. Kate Beard-Tisdale, Professor in Spatial Information Science and Engineering

Werner Kuhn, Professor in Geoinformatics, Universität Münster

Kathleen Stewart Hornsby, Assistant Research Professor in National Center for  
Geographic Information and Analysis

Michael F. Worboys, Professor in Spatial Information Science and Engineering

© 2007 Yohei Kurata

All Rights Reserved

## **LIBRARY RIGHTS STATEMENT**

In presenting this thesis in partial fulfillment of the requirements for an advanced degree at The University of Maine, I agree that the Library shall make it freely available for inspection. I further agree that permission for “fair use” copying of this thesis for scholarly purposes may be granted by the Librarian. It is understood that any copying or publication of this thesis for financial gain shall not be allowed without my written permission.

Signature:

Date:

# ARROW SYMBOLS: THEORY FOR INTERPRETATION

By Yohei Kurata

Thesis Advisor: Dr. Max J. Egenhofer

An Abstract of the Thesis Presented  
in Partial Fulfillment of the Requirements for the  
Degree of Doctor of Philosophy  
(in Spatial Information Science and Engineering)  
May, 2007

People often sketch diagrams when they communicate successfully among each other. Such an intuitive collaboration would also be possible with computers if the machines understood the meanings of the sketches. Arrow symbols are a frequent ingredient of such sketched diagrams. Due to the arrows' versatility, however, it remains a challenging problem to make computers distinguish the various semantic roles of arrow symbols. The solution to this problem is highly desirable for more effective and user-friendly pen-based systems. This thesis, therefore, develops an algorithm for deducing the semantic roles of arrow symbols, called the *arrow semantic interpreter (ASI)*.

The *ASI* emphasizes the structural patterns of arrow-containing diagrams, which have a strong influence on their semantics. Since the semantic roles of arrow symbols are assigned to individual arrow symbols and sometimes to the groups of arrow symbols, two types of the corresponding structures are introduced: the *individual structure* models the spatial arrangement of components around each arrow symbol and the *inter-arrow structure* captures the spatial arrangement of multiple arrow symbols. The semantic roles assigned to individual arrow symbols are classified into *orientation*,

*behavioral description, annotation, and association*, and the formats of individual structures that correspond to these four classes are identified. The result enables the derivation of the possible semantic roles of individual arrow symbols from their individual structures. In addition, for the diagrams with multiple arrow symbols, the patterns of their inter-arrow structures are exploited to detect the groups of arrow symbols that jointly have certain semantic roles, as well as the nesting relations between the arrow symbols.

The assessment shows that for 79% of sample arrow symbols the *ASI* successfully detects their correct semantic roles, even though the average number of the *ASI*'s interpretations is only 1.31 per arrow symbol. This result indicates that the structural information is highly useful for deriving the reliable interpretations of arrow symbols.

## ACKNOWLEDGMENTS

First, I would like to thank all my family in Japan, who respected my decision to study abroad and supported me from the other side of the Earth. My deepest thanks also go to my advisor, Dr. Max Egenhofer, who has always cheered me up, given me insightful advice, and kept stimulating my academic interest. Other committee members, Dr. Kate Beard, Dr. Mike Worboys, Dr. Kathleen Hornsby, and Dr. Werner Kuhn, also helped me considerably to complete this work. My former advisor, Dr. Atsuyuki Okabe, strongly encouraged me to study abroad. Without his push I would have missed the exciting experience in working academically with international people. Dr. Christian Claramunt, Dr. Lars Kulik, Dr. Richard Lowe, Dr. Atushi Shimojima, Dr. Barbara Tversky gave me great advice on my work and presentations. Makiko Matsuoka helped my life in Maine and also gave me some useful suggestions on this work. Finally, I'd like to thank my friends, Cindy and Maurice Brown, Taichi Godo, Michael Hendricks, Hae-kyong Kang, Inga Mau, Errol Millios, Tomokazu Miyakozawa, Yuri Uesaka, Caixia Wang, Markus Wersch, Dominik Wilmsen, and Teruyoshi Yoshida, who gave warm comments on my work and cheered me a lot.

Dr. Ronald Ferguson from the Georgia Institute of Technology was the external reader on my dissertation. My special thanks go to him for his advice and encouragement.

This work was partially supported by the National Geospatial-Intelligence Agency under grant numbers NMA201-01-1-2003 and NMA401-02-1-2009, a University of Maine International Tuition Scholarship, and a University of Maine Graduate Summer Research Award.

# TABLE OF CONTENTS

ACKNOWLEDGMENTS .....	iii
LIST OF TABLES .....	ix
LIST OF FIGURES .....	xii
Chapter 1 INTRODUCTION.....	1
1.1. Difficulty in Deriving Interpretations of Arrow Symbols.....	4
1.2. Research Approach.....	6
1.3. Hypothesis.....	7
1.4. Major Results .....	8
1.5. Intended Audience.....	9
1.6. Thesis Organization.....	10
Chapter 2 RELATED WORK.....	13
2.1. Definition of Arrow Symbols.....	14
2.2. Semantic Roles of Arrow Symbols .....	16
2.2.1. Specifying a Directional Property .....	17
2.2.2. Illustrating a Spatial Movement .....	19
2.2.3. Illustrating Communication.....	21
2.2.4. Illustrating Continuous Existence.....	22
2.2.5. Indicating a Temporal Order.....	23
2.2.6. Labeling.....	25
2.2.7. Indicating Ordered Binary Relations.....	25
2.3. Characteristics of Arrow Symbols and Diagrams .....	26

2.4. Computational Understanding of Diagrams.....	29
2.4.1. Current Diagram-Understanding Systems.....	29
2.4.2. What is Diagram Understanding?.....	32
2.4.3. Diagram-Understanding Systems and Arrow Symbols.....	34
2.5. Spatial Relations between Line Segments .....	35
2.6. Summary .....	39
Chapter 3 STRUCTURES OF ARROW DIAGRAMS .....	40
3.1. Terminology .....	41
3.2. Individual Structures .....	42
3.2.1. Three Component Slots .....	42
3.2.2. Definition of Individual Structures.....	43
3.2.3. Pattern of Individual Structures.....	45
3.3. Inter-Arrow Structures .....	49
3.3.1. Definition of Inter-Arrow Structures .....	50
3.3.2. Topological Relations between Two Arrow Symbols.....	50
3.3.3. Analysis of Topological Relations Established by Direct Links .....	55
3.4. Demonstration.....	60
3.4.1. Example 1: Wolves' Attack Scenario.....	61
3.4.2. Example 2: Industrial Revolution Scenario.....	63
3.5. Summary .....	64
Chapter 4 INTERPRETATIONS OF ARROW SYMBOLS IN 1-ARROW DIAGRAMS .....	65
4.1. Classification of Semantic Roles .....	66



4.2. Basic formats of Individual Structures.....	68
4.2.1. Basic Formats for Orientation .....	68
4.2.2. Basic Formats for Behavioral Description .....	70
4.2.3. Basic Formats for Annotation.....	74
4.2.4. Basic Formats for Association.....	75
4.3. Rules for Optional Components.....	77
4.3.1. Adjective Components .....	77
4.3.2. Adverbial Components.....	78
4.4. Interpretations of Arrow Symbols in Simple 1-Arrow Diagrams .....	79
4.4.1. Patterns of Simple 1-Arrow Diagrams for Orientation .....	80
4.4.2. Patterns of Simple 1-Arrow Diagrams for Behavioral Description .....	81
4.4.3. Patterns of Simple 1-Arrow Diagrams for Annotation.....	82
4.4.4. Patterns of Simple 1-Arrow Diagrams for Association.....	83
4.4.5. Comparison of Patterns .....	84
4.5. Interpretation of Arrow Symbols in General 1-Arrow Diagrams .....	85
4.6. Summary .....	87

Chapter 5 INTERPRETATIONS OF ARROW SYMBOLS IN MULTI-ARROW

DIAGRAMS .....	89
5.1. Terminology .....	90
5.2. Group Roles of Arrow Symbols.....	91
5.2.1. Indicating Element-Sharing.....	91
5.2.2. Formulating a Branching Process.....	92
5.2.3. Indicating Interactions during Transition .....	93

5.2.4. Illustrating an Extent Change .....	95
5.2.5. Specifying an Interval.....	96
5.3. Nesting of Arrow Diagrams .....	97
5.4. Interpretation of Arrow Symbols in Multi-Arrow Diagrams .....	98
5.4.1. Detection of Subordinate Arrow Diagrams .....	100
5.4.2. Tentative Deduction of Group Roles .....	100
5.4.3. Deduction of Individual Roles.....	103
5.4.4. Validation of Tentative Group Roles .....	103
5.5. Demonstration.....	104
5.5.1. Example 1: Wolves' Attack Scenario.....	104
5.5.2. Example 2: Industrial Revolution Scenario.....	105
5.6. Summary .....	107
Chapter 6 EVALUATION.....	108
6.1. Method .....	108
6.2. Statistical Overview .....	115
6.3. Validity of the Hypothesis.....	116
6.4. Statistical Analysis in Terms of Each Class of Semantic Roles .....	117
6.5. Analysis of Misinterpretations .....	120
6.5.1. Oversight .....	120
6.5.2. Partial Match.....	122
6.5.3. No-Answer.....	124
6.6. Summary .....	126
Chapter 7 CONCLUSIONS.....	127

7.1. Summary of Thesis .....	127
7.2. Results and Major Findings .....	128
7.2.1. Classification of Individual Roles .....	128
7.2.2. Investigation of Group Roles.....	129
7.2.3. Two Syntactic Structures of Arrow Diagrams .....	129
7.2.4. An Algorithm for Deducing Individual Roles of Arrow Symbols.....	130
7.2.5. The Arrow Symbol Interpreter ( <i>ASI</i> ) .....	130
7.3. Future Work.....	131
7.3.1. Remediation.....	131
7.3.1.1. Reclassification of Individual Roles .....	131
7.3.1.2. Detection of Impractical Interpretations .....	133
7.3.1.3. Detection of Omitted Components .....	136
7.3.2. Automation .....	137
7.3.3. Detail Enrichment.....	138
7.3.4. Applications.....	139
GLOSSARY .....	140
BIBLIOGRAPHY.....	146
BIOGRAPHY OF THE AUTHOR.....	161

## LIST OF TABLES

Table 3.1: Number of patterns of the 9-link matrices satisfying the constraint.....	55
Table 3.2: 68 topological relations between two arrow symbols, which have no indirect links.....	56
Table 4.1: Nine prescriptive patterns that individual structures must satisfy when arrow symbols are used for <i>orientation</i> ( $s$ : subject, $PC_{L O E}$ : $PC_L$ , $PC_O$ , or $PC_E$ ). .....	70
Table 4.2: Fifteen basic formats of individual structures that correspond to <i>behavioral description</i> ( $s$ : subject, $e$ : entity involved in the transition, $p$ : position related to the transition, $e p$ : either $e$ or $p$ , $[e p]^n$ : one or more $e p$ ). .....	72
Table 4.3: 104 prescriptive patterns that individual structures must satisfy when arrow symbols are used for <i>behavioral description</i> ( $s$ : subject, $e$ : entity involved in the transition, $p$ : position related to the transition). .....	73
Table 4.4: Four prescriptive patterns that individual structures must satisfy when arrow symbols are used for <i>annotation</i> ( $l$ : label, $s$ : subject). .....	74
Table 4.5: Associated subjects and effective relations between them, which may naturally determine the order of the associated subjects. ....	76
Table 4.6: Sixteen prescriptive patterns that individual structures must satisfy when arrow symbols are used for <i>association</i> ( $s_1$ , $s_2$ : associated subjects). .....	76
Table 4.7: Information provided by adverbial components. ....	79

Table 4.8: Five formats and fifteen patterns of simple individual structures that correspond to <i>orientation</i> ( <i>s</i> : subject, <i>c<sub>av</sub></i> : adverbial component) .....	80
Table 4.9: Eighteen formats and 104 patterns of simple individual structures that correspond to <i>behavioral description</i> ( <i>s</i> : subject, <i>e</i> : entity involved in the transition, <i>p</i> : position related to the transition). The patterns may overlap between the rows.....	82
Table 4.10: One format and four patterns of simple individual structures that correspond to <i>annotation</i> ( <i>l</i> : label, <i>s</i> : subject).....	83
Table 4.11: Two formats and 32 patterns of simple individual structures that correspond to <i>association</i> ( <i>s<sub>1</sub></i> , <i>s<sub>2</sub></i> : associated subjects, <i>c<sub>av</sub></i> : adverbial component). .....	83
Table 5.1: Individual roles of arrow symbols presumed by their group role.....	99
Table 5.2: Spatial arrangements required for the arrow symbols with the group roles in Section 5.2.....	101
Table 5.3: Components required for the arrow symbols with the group roles in Section 5.2.....	102
Table 5.4: Indirect reference of arrow symbols specified by the group roles in Section 5.2.....	103
Table 6.1: Four types of interpretation result with regard to a semantic role <i>r<sub>i</sub></i> .....	114
Table 6.2: The interpretation results of the 94 arrow symbols with regard to <i>orientation</i> .....	118
Table 6.3: The interpretation results of the 94 arrow symbols with regard to with regard to <i>behavioral description</i> .....	118

Table 6.4: The interpretation results of the 94 arrow symbols with regard to with regard to <i>annotation</i> .....	118
Table 6.5: Number of the four types of interpretation results with regard to <i>association</i> .....	119
Table 6.6: Probability that each interpretation result with regard to a semantic role $r_i$ occurs if two nominal variables are independent. ....	119
Table 6.7: Individual structures of the 33 arrow symbol which yielded <i>partial match</i> ( $[MC]^*$ : arbitrary number of <i>MC</i> ).....	123

## LIST OF FIGURES

Figure 1.1: Diagrams with arrow symbols which describe dynamic spatial information: (a) a process that the El Niño effect indirectly influences the price of tofu in Japan and (b) how to build a LEGO model.....	2
Figure 1.2: Two arrow-containing diagrams where a group of arrow symbols has its own semantic role: (a) representing expansion and (b) indicating multiple possibilities. ....	5
Figure 2.1: Examples of non-simple arrow symbols. ....	15
Figure 2.2: A collection of semantic roles of arrow symbols (Horn 1998).....	16
Figure 2.3: The presumably earliest diagram with an arrow symbol used for specifying a directional property other than map’s North, drawn in 1737 (Gombrich 1990).....	17
Figure 2.4: Two arrow-containing diagrams, in which each arrow symbol metaphorically indicates increase or stability of a value. ....	18
Figure 2.5: Two arrow plots, capturing a vector field (Garcke <i>et al.</i> 2000). ....	19
Figure 2.6: (a) A diagram in Galilei’s manuscript showing arrow symbols that illustrates the course of movement of Jupiter’s moon (Westendorp 2006). (b) The pictorial message mounted to Pioneer 10 spacecraft in which an arrow symbol illustrates the course of movement of the spacecraft (Sagan and Sagan 1972). ....	20
Figure 2.7: Arrow symbol capture a typical immigration route in the New York State (Monmonier 1990).....	20

Figure 2.8: Two arrow-containing diagrams in which each arrow symbol illustrates a spatial interaction and its scale between two locations: (a) Gradel and Crutzen (1995) and (b) Tobler (1987).	22
Figure 2.9: An arrow symbol illustrating a communication between two objects (Worboys and Duckham 2004).	22
Figure 2.10: A timetable in which each arrow symbol captures continuous existence of a job phase over a time interval (Horn 1998).	23
Figure 2.11: Two flowcharts in which each arrow symbol indicates a temporal order: (a) Horn (1998) and (b) Hornsby and Egenhofer (2000).	24
Figure 2.12: An illustration of a computer's hard drive, in which each arrow symbols attaches a text label to a mechanical component of the drive (Worboys and Duckham 2004).	25
Figure 2.13: A directed graph, in which each arrow symbol captures an ordered binary relation between two elements (Lipschutz and Lipson, 1997).	26
Figure 2.14: ASSIST (Alvarado and Davis 2001b; 2001a; Davis 2002).	30
Figure 2.15: A sketch-based system that supports GUI designs (Landay and Myers 2001).	30
Figure 2.16: sKEA (Ferguson and Forbus 2002; Forbus and Usher 2002).	31
Figure 2.17: QuickSet (Cohen <i>et al.</i> 1997; Johnston 1998; Cohen <i>et al.</i> 2000; Oviatt and Cohen 2000).	32
Figure 2.18: nuSketch COA creator (Forbus <i>et al.</i> 2001; Ferguson and Forbus 2002).	32
Figure 3.1: Three component slots associated with an arrow symbol.	42



Figure 3.2: An arrow symbol with multiple components in each component slot. ....	43
Figure 3.3: The label “ <i>WATER</i> ” is attached to only one of the dashed arrow symbols, but is conceptually assigned to the body slot of all dashed arrow symbols.....	43
Figure 3.4: Two pairs of 1-arrow diagrams, each with the same components in different component slots, illustrate different semantics. ....	44
Figure 3.5: A 1-arrow diagram with two primary components (a tourist icon and a firework icon) and three modifier components (“ <i>Mr. K</i> ”, “ <i>July 4</i> ”, and “ <i>Boston</i> ”).....	45
Figure 3.6: Two 1-arrow diagrams, whose head components are apparently same, but belong to different component types: (a) object (a broken car) and (b) event (a car accident).....	47
Figure 3.7: Arrow symbols with the same tail components and different types of head components: (a) object, (b) an event, and (c-d) a location. ....	48
Figure 3.8: Four 1-arrow diagrams with the patterns of their individual structures. ....	49
Figure 3.9: Six 2-arrow diagrams where arrow symbols are connected by (a) a head-head intersection, (b) references to the same “ <i>Inspection</i> ” label, (c) both a head-tail intersection and references to the same <i>landing strip</i> icon, (d) a body-tail intersection, (e) references to the same <i>cell phone</i> and <i>database</i> icons, and (f) both a tail-tail intersection and references to the same “ <i>Inspection</i> ” label.....	51
Figure 3.10: The 9-link matrices that capture the topological relations between the pairs of arrow symbols in Figures 3.9a-f. ....	53

Figure 3.11: The conceptual neighborhood graph of the relations #1 through #34, illustrated on a plane. ....	58
Figure 3.12: Characteristics of the conceptual neighborhood graph in Figure 3.11: (a) symmetric and converse relations and (b) the four subgraphs that are obtained by reversing the direction of an arrow symbol when mirroring the relation along the graph's horizontal or vertical axis.....	59
Figure 3.13: The transition from (a) the flat conceptual neighborhood graph of the relations #1 through #34 with repeated columns and rows to (b) a graph displayed on the surface of a torus, which is obtained by gluing together the repeated rows and columns along the fringes of the flat graph .....	59
Figure 3.14: Two structures of the conceptual neighborhood graph of the relations #1 through #68, where nodes are aligned on (a) two parallel planes and (b) the surfaces of two nested tori.....	60
Figure 3.15: Two 2-arrow diagrams that capture that (a) a pack of wolves splits into two packs, which approach a sheep from front and behind, and that (b) the industrial revolution leads to the population drift from rural area to urban area. ....	61
Figure 3.16: The process of deriving the individual structures and the inter-arrow structure of the multi-arrow diagram in Figure 3.15a.....	62
Figure 4.1: Classification of semantics roles of arrow symbols. ....	66
Figure 4.2: Diagrams with arrow symbols for <i>orientation</i> , specifying (a) the moving direction of a vehicle, (b) a wind direction of a point in	

Maine, and (c) the direction of an external force by which a board cracks. ....	68
Figure 4.3: Three basic formats of individual structures that correspond to <i>orientation</i> ( <i>s</i> : subject). ....	69
Figure 4.4: An arrow diagram with five arrow symbols, all used for <i>annotation</i> . ....	74
Figure 4.5: Only one basic format of the individual structures that correspond to <i>annotation</i> ( <i>l</i> : label, <i>s</i> : subject). ....	74
Figure 4.6: Only one basic format of the individual structures that correspond to <i>association</i> ( <i>s</i> <sub>1</sub> , <i>s</i> <sub>2</sub> : associated subjects) ....	75
Figure 4.7: A 1-arrow diagram with two adjective components, “ <i>Mr. K</i> ” and “ <i>Maine</i> ,” each of which specifies the name of an entity illustrated nearby. ....	77
Figure 4.8: The number of patterns of simple individual structures that correspond to each class of semantic roles. ....	84
Figure 4.9: Simple 1-arrow diagrams whose individual structures have the patterns (a) ( <i>PC<sub>L</sub></i> , <i>PC<sub>O</sub></i> , <i>PC<sub>L</sub></i> ), (b) ( <i>MC</i> , <i>-</i> , <i>PC<sub>O</sub></i> ), (c) ( <i>MC</i> , <i>PC<sub>O</sub></i> , <i>PC<sub>L</sub></i> ), which corresponds to one, two, and no classes of semantic roles, respectively. ....	85
Figure 5.1: Synthesis of two 1-arrow diagrams yields a multi-arrow diagram, which captures additional semantics: the pack of wolves splits into two packs. ....	89

Figure 5.2: Three 2-arrow diagrams capturing pairs of element-sharing individual semantics. In addition, (b) and (c) imply that the pairs are mutually exclusive and synchronized, respectively. ....	92
Figure 5.3: The same branching processes are captured by (a) a pair of arrow symbols with a direct body-tail link and (b) a pair of arrow symbols with an indirect tail-tail link.....	93
Figure 5.4: Six 2-arrow diagrams with different types of direct links between arrow symbols, which indicate different interactions between the subjects: (a) <i>separation</i> , (b) <i>meeting</i> , (c) <i>contact</i> , (d) <i>drop-by</i> , (e) <i>diversion</i> , and (f) <i>confluence</i> .....	95
Figure 5.5: Two multi-arrow diagrams in which a group of arrow symbols is used for illustrating (a) the diffusion of balloons and (b) the expansion of a balloon.....	96
Figure 5.6: Two multi-arrow diagrams in which a pair of reversely directed arrow symbols is used for specifying the interval of (a) wavelength of electric waves assigned to televisions and radios and (b) a pulse (1997).....	96
Figure 5.7: (a) The central arrow symbol points to “ <i>Fish catch</i> ,” but conceptually refers to the subordinate arrow diagram “ <i>Fish catch</i> ↓”; and (b) the central arrow symbol points to the horizontal arrow symbol, but conceptually refers to the subordinate arrow diagram “ <i>Rural area</i> → <i>Urban area</i> .” <small><i>population</i></small> .....	97

Figure 5.8: Two 2-arrow diagrams which capture (a) a pack of wolves splits into two packs, which approach a sheep from front and behind and (b) the industrial revolution leads to the population drift from rural area to urban area.....	104
Figure 6.1: A prototype of the <i>ASI</i> .....	109
Figure 6.2: Semantic roles of 304 sample arrow symbols found in a GIS textbook (Jones 1997).....	110
Figure 6.3: Semantic roles of (a) 745 arrow symbols found in a biology textbook (Comins and Kaufmann III 2003), Part I and II, and (b) 956 arrow symbols found in an astronomy textbook (Avila 1992).....	111
Figure 6.4: Two arrow-containing diagrams with a set of similar arrow symbols. ....	112
Figure 6.5: Semantic roles of the 94 representative arrow symbols.....	112
Figure 6.6: The number of interpretations that the <i>ASI</i> deduced for the 94 representative arrow symbols. ....	115
Figure 6.7: The interpretation results of the 94 representative arrow symbols.....	116
Figure 6.8: Two arrow-containing diagrams in which arrow symbols are used for <i>orientation</i> in irregular formats: (a) the arrow symbol points to an adverbial component “ <i>Azimuth direction</i> ” and (b) each arrow symbol refers to two locations.....	121
Figure 6.9: An arrow-containing diagram in which arrow symbols are used for <i>behavioral descriptions</i> , although the subjects are not illustrated in the diagrams.....	121

Figure 6.10: An arrow-containing diagram where the white arrow symbol indirectly refers to the empty table in the previous line.....	122
Figure 6.11: Two arrow-containing diagrams, each with an arrow symbol whose individual structure has the pattern of $(PC_o[MC]^*, [MC]^*, PC_o[MC]^*)$ . .....	124
Figure 6.12: Two arrow-containing, in which two arrow symbols are used for <i>interval specification</i> (a) by themselves or (b) in combination. ....	125
Figure 6.13: Two arrow-containing, each with an arrow symbol used for (a) <i>pointing</i> and (b) <i>gradation</i> . ....	125
Figure 7.1: A model of evolutions of arrow symbols' semantic roles. ....	133
Figure 7.2: Three arrow diagrams whose individual structures has the same patterns, $(PC_o, -, PC_LMC)$ , illustrating (a) <i>behavioral description</i> , (b) no <i>behavioral description</i> due to the immobility of the broken car, and (c) no <i>behavioral description</i> due to the (immobile) Brandenburg Gate. ....	134
Figure 7.3: (a) Hierarchy of an operation <i>move</i> and its subclasses and (b) hierarchy of <i>animal</i> and its super/subclasses with inheritance of mobility.....	135
Figure 7.4: An arrow diagram that may illustrate two different scenarios depending on the context: a <i>vehicle approaches a person (encounter)</i> or a <i>person leaves a vehicle (division)</i> . ....	138

## Chapter 1

### INTRODUCTION

People often sketch diagrams to facilitate their communication. Diagrams clarify mental shapes and structures, which are difficult to communicate verbally. If computers would understand such diagrams, people could operate information systems more intuitively, for instance, by sketching diagrams to explain their ideas and knowledge. Indeed, a number of pen-based computer systems that understand diagrams have been developed, and their usefulness has been reported repeatedly (Oviatt 1996; Egenhofer 1997; Landay and Myers 2001; Davis 2002; Ferguson and Forbus 2002). These pioneering systems have demonstrated that computational diagram understanding is a highly promising technology that will enrich human-computer interactions.

Arrow symbols are used in a variety of diagrams, such as pictorial instructions, route maps, traffic signs, guideboards, route maps, and flowcharts (Horn 1998; Wildbur and Burke 1998). Tversky and Lee (1999) observed that arrow symbols were used in about a half of the sketch maps that they analyzed. One reason for the popularity of arrow symbols is that they are convenient—even though their shapes are extremely simple, they capture a large variety of semantics, such as directions, movements, interactions, transitions, orders, and relations. In addition, arrow symbols enable us to communicate dynamic spatial information even in a static diagram. For instance, Figure 1.1a contains only a few words and arrow symbols over a background map, but people easily read the complicated mechanism where the El Niño effect (i.e., sea temperature rise in the

Southeastern Pacific Ocean) indirectly influences the rise of the price of tofu in Japan. Similarly, arrow symbols are particularly useful for illustrating such dynamic spatial processes as spatial diffusion of ideas, migrations of tribes and refugees, advances of armies, and so forth (Monmonier 1990). Interestingly, people can communicate such dynamic spatial information more intuitively by arrow-containing diagrams than by verbal expressions. Even small children, who have not yet learnt a written language, can understand the pictorial instructions of toys, which typically use arrow symbols (Figure 1.1b). In this way, the convenience and expressive power of arrow symbols leads to the frequent use of arrow symbols in people’s daily communication.

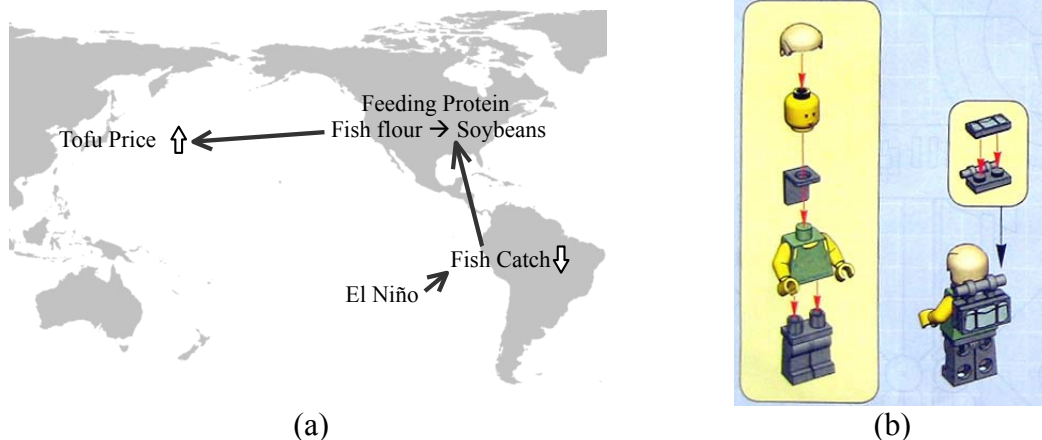

Figure 1.1: Diagrams with arrow symbols which describe dynamic spatial information: (a) a process that the El Niño effect indirectly influences the price of tofu in Japan and (b) how to build a LEGO model.

An important feature of arrow symbols is that they do not describe any meaning by themselves—they provide the information about the other elements to which the arrow symbols refer. This function of arrow symbols is called their *semantic role*. Arrow symbols may have a large variety of semantic roles, such as specifying the moving



direction of an object and indicating a causal relation between two events. Semantic roles are slightly different from *meanings*, because, for instance, annotation (attaching a label to an element) is a semantic role that an arrow symbol may have (Section 2.2.6), but not the meaning that the arrow symbol expresses. On the other hand, to express a certain meaning (for instance, *increase*) is considered as a semantic role of an arrow symbol.

In order to understand an arrow-containing diagram correctly, the diagram readers have to figure out the semantic roles of arrow symbols in the diagram. For instance, to understand Figure 1.1b, the diagram readers (probably small children and their parents) have to figure out that most arrow symbols instruct the readers to attach one Lego block to another. Unfortunately, it is not always easy, especially for computers, to figure out such semantic roles of arrow symbols. For example, in Figure 1.1a, people who do not know the El Niño effect may consider that the arrow symbol departing from “*El Niño*” illustrates the spatial movement of “*Fish Catch*” to South America, or attaches a label “*El Niño*” to “*Fish*.” To avoid such misinterpretations, current pen-based systems restrict the semantic roles of arrow symbols to a small set (Alvarado and Davis 2001b; Landay and Myers 2001; Kurtoglu and Stahovich 2002), or require their users to specify the semantic role of every arrow symbol by speech (Oviatt and Cohen 2000), use of different-shaped arrow symbols (Forbus *et al.* 2001), text input, or selection from a menu (Forbus and Usher 2002). Consequently, the current pen-based systems prevent their users from making full use of arrow symbols in human-computer interactions.

To overcome this blockage, this thesis aims at enabling computers to derive the semantic roles of arrow symbols in sketched diagrams. To this goal, this thesis develops

an algorithm for deducing the semantic roles of arrow symbols. Such deduced semantic roles are called the *interpretations* of arrow symbols. With a capability of deriving interpretations of arrow symbols, pen-based information systems will understand hand-drawn diagrams with less human aid. Consequently, people will be able to operate these systems more intuitively and effectively as if they collaborate with other people.

### **1.1. Difficulty in Deriving Interpretations of Arrow Symbols**

Deriving interpretations of arrow symbols requires an intricate reasoning process. For instance, in Figure 1.1a, a typical interpretation of the downward arrow symbol next to “*Fish Catch*” is a representation of the *decrease* of the fish catch. Most people agree with this interpretation, as they know that fish catch is a quantitative variable and also that a short downward arrow symbol, attached to a quantitative variable, may represent the decrease of its value. Other interpretations, such as a specification of the moving direction of *Fish Catch*, may be possible, but this case lacks the evidence to support such alternative interpretations. Similarly, in Figure 1.1a, a typical interpretation of the arrow symbol connecting “*El Niño*” with “*Fish Catch*↓” is an indication of the causal relation between the El Niño effect and the decrease of fish catch. The reader may come up with this interpretation if the reader knows that both “*El Niño*” and the decrease of fish catch are events and also that an arrow symbol connecting two events may indicate a causal relation. Also, this interpretation is persuasive if the reader knows that the *El Niño* effect typically influences fishing. In this way, the interpretations of arrow symbols depend

partly on the reader’s background knowledge about both the illustrated elements and what semantic roles arrow symbols may have in each situation. It is not clear, however, what range of knowledge is actually necessary (and sufficient) for deriving the interpretations of arrow symbols.

Another difficulty associated with the interpretations arises when the semantic roles of arrow symbols are assigned to a group of arrow symbols instead of individual arrow symbols. For example, the arrow symbols in Figure 1.2a jointly represent an expansion of a balloon and those in Figure 1.2b jointly indicate that the “*inspection*” event is followed by the “*shipping*” or “*disposal*” event, but not both. In this way, arrow symbols may form a group and jointly have an additional semantic role; however, it is not obvious which set of arrow symbols in the diagram organizes a group and what semantic roles these arrow symbols jointly have.

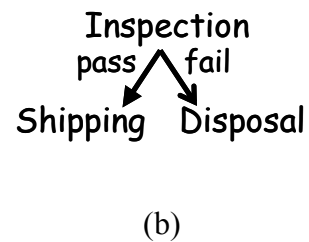
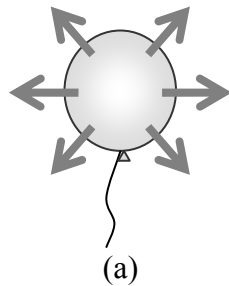

Figure 1.2: Two arrow-containing diagrams where a group of arrow symbols has its own semantic role: (a) representing expansion and (b) indicating multiple possibilities.

## 1.2. Research Approach

It is impossible to derive the interpretation of an arrow symbol from the arrow symbol alone. As observed in the previous examples, the semantic role of an arrow symbol depends on what elements the arrow symbol refers to and how (being attached to one element, connecting two elements, and so forth). Therefore, this thesis emphasizes the influence of these arrow-related elements and their spatial arrangement.

The combination of arrow symbols with the elements to which the arrow symbols refer is considered a syntactic unit, called an *arrow diagram* (Kurata and Egenhofer 2005a; 2006c). An arrow diagram with one arrow symbol is called a *1-arrow diagram*, whereas an arrow diagram with more than one arrow symbol is called a *multi-arrow diagram* (Figure 1.1a). The elements to which the arrow symbols refer are called the *components* of the arrow diagram. A component may be specified as an icon, a text label, a small diagram embedded in the diagram, or a specific position of a picture, a map, or an image.

In order to systematically study the influence of components and their spatial arrangement, this thesis develops a model of components' arrangement and distinguishes the patterns of such arrangement based on the classification of the components. This thesis also considers the arrangement of multiple arrow symbols, because such properties as symmetry (Figure 1.2a) and connection (Figure 1.2b) contribute to the organization of arrow symbols and, accordingly, influence their semantic roles. For this purpose, spatial

relations between two arrow symbols, which form the basis of the arrangement of multiple arrow symbols, are analyzed.

In addition to the arrangement of components and arrow symbols, the visual appearance of arrow symbols (for instance, color and width) and context may also influence their semantic roles. Tversky *et al.* (2007) demonstrates that carefully crafted context can disambiguate meanings of depictive symbols, including arrow symbols, just as they can disambiguate meanings of words. This thesis, however, ignores the arrow symbols' appearance and underlying context, because these are considered here as additional clues that narrow down the candidates for the correct semantic roles, but would not contribute directly to deriving those candidates.

### **1.3. Hypothesis**

The goal of this research is to develop an algorithm for interpreting arrow symbols, with which computers can understand appropriately what their users want to represent by each arrow symbol in sketched diagrams. The interpretation method makes use of the spatial arrangement of arrow symbols and components, assuming that such arrangement is the most important factor for the interpretations of arrow symbols. A key question is how reliable the interpretations deduced by this method are. Thus, this thesis examines the following hypothesis:

*The interpretation method, which deduces interpretations from the spatial arrangement of arrow symbols and components in arrow diagrams, detects the*

*correct semantic roles of arrow symbols at a significantly higher rate than random choices.*

To assess this hypothesis, a prototype system, which implements the developed interpretation method, deduces the interpretations of sample arrow symbols. Then, the correctness of these interpretations is statistically evaluated.

#### **1.4. Major Results**

The primary achievement of this thesis is the determination of an algorithm for deducing semantic roles of arrow symbols in arrow diagrams. This method is called the *arrow symbol interpreter (ASI)*, since it works as an interpreter of arrow symbols to pen-based computer systems. In addition, this thesis accomplishes:

- recognition and classification of major semantic roles that arrow symbols may individually or jointly have,
- models of the spatial arrangement of components and arrow symbols in arrow diagrams,
- identification of the relation between the semantic roles of arrow symbols and the structural patterns associated with these arrow symbols, and
- finding of background knowledge necessary for the interpretation of arrow symbols.

The *ASI* provides computers a capability of deriving the interpretations of arrow symbols with little human aid. Thus, pen-based information systems equipped with

the *ASI* will be able to understand arrow-containing diagrams more intelligently. As a result, people will be able to operate these systems more intuitively and efficiently by sketching a diagram to explain their knowledge and ideas.

Another expected use of the *ASI* is to analyze any potential ambiguity of arrow symbols when designing a diagram. If an arrow symbol is fundamentally ambiguous, the *ASI* will give multiple interpretations, including the interpretations that differ from the presenter's original intention. Thanks to this feature, diagram designers can test their diagrams with the *ASI*, examining whether the diagram has a risk of misinterpretations. This implies that there are two types of the correct semantic roles: (1) the *intended* semantic roles of an arrow symbol, which corresponds to the semantic role that the diagram drawer has originally intended, and (2) the *consistent* semantic roles with which the diagram captures the semantics consistent with a common-sense world. The *ASI* aims at deriving the consistent interpretations of arrow symbols.

## **1.5. Intended Audience**

Although this thesis is originally motivated by an interest in the diagrammatic representations of spatio-temporal information at cartographic scales, the concepts discussed in this thesis are not restricted to spatial information studies, but apply to a much larger variety of domains where arrow-containing diagrams are used for communication. The primary audience of this thesis is researchers and practitioners from the fields of spatial information science, computer science, artificial intelligence,

diagrammatic communication studies, cartography, and geography. Particularly, this thesis should be of interest to system designers who aim at developing intuitive human-machine interfaces. At the same time, since arrow symbols are commonly used in a large variety of scientific and non-scientific domains, this thesis should also be of interest to anyone who has an interest in how arrow-containing diagrams are communicated and how such diagrams should be drawn.

## **1.6. Thesis Organization**

This thesis is organized into seven chapters. Chapter 2 reviews related work, starting with the discussion about the definition of arrow symbols and an investigation of major semantic roles of arrow symbols. Then, current pen-based information systems are reviewed, through which the necessity of an algorithm for interpreting arrow symbols is confirmed. Also, this chapter reviews the studies of spatial line-line relations, which provide a foundation for modeling the spatial arrangement of arrow symbols in multi-arrow diagrams.

Chapter 3 formalizes the structures of arrow diagrams from two viewpoints. The *individual structure* models the spatial arrangement of components around each arrow symbol, while the *inter-arrow structure* models the spatial arrangement of multiple arrow symbols in the diagram. These two structures work complementarily, as they capture the configuration of arrow diagrams from local and global perspectives, respectively.



Chapters 4 and 5 develop an algorithm for deducing the interpretation of arrow symbols. First, Chapter 4 considers 1-arrow diagrams, where the interpretation of the arrow symbol is derived from its individual structure alone. This chapter distinguishes four classes of the semantic roles of arrow symbols. Then, the prescriptive patterns that individual structures must satisfy when arrow symbols have each class of semantic roles, as well as the rules for adding optional components, are identified. The obtained knowledge makes it possible to determine all classes of semantic roles that correspond to a given individual structure, which is essential to derive the interpretations of individual arrow symbols.

Chapter 5 considers multi-arrow diagrams, where arrow symbols may organize a group and jointly have a certain semantic role. Also, in a multi-arrow diagram, an arrow symbol may refer to an inner arrow diagram, thereby forming a nested structure. This chapter analyzes how the spatial arrangement of arrow symbols corresponds to the organization of arrow symbol groups and nested structures, and exploits those correspondences to the interpretations of arrow symbols in multi-arrow diagrams.

Chapter 6 conducts an experiment to examine the hypothesis. In this experiment, an *ASI*'s prototype makes interpretations of sample arrow symbols in the figures of a GIS textbook and the correctness of *ASI*'s interpretations is statistically evaluated. From this result and the detailed analysis of misinterpreted samples this chapter addresses problems in the current *ASI* that have led to misinterpretations of arrow symbols

Chapter 7 concludes this thesis with a summary of major results and a discussion of future research problems.

## **Chapter 2**

### **RELATED WORK**

As one of the most fundamental elements in diagrams, arrow symbols are widely used across domains, generations, cultures, and languages. Naturally, arrow symbols are discussed and investigated in a large variety of contexts. Sections 2.1-2.5 review the relevant work with the following five fundamental questions: (1) what are arrow symbols, (2) how do people use arrow symbols, (3) why do people frequently use arrow symbols, (4) what problems happen when arrow symbols are used in human-machine interactions, and (5) what models are available for structuring arrow diagrams. The answers to these questions contribute to the interpretation of arrow symbols.

The review starts with definitions of arrow symbols (Section 2.1) and major semantic roles that arrow symbols have (Section 2.2). Section 2.3 discusses the characteristics of both arrow symbols and diagrams that motivate people to use arrow symbols. Section 2.4 reviews major pen-based computer systems, discusses the goal of diagram understanding technologies, and identifies the necessity of an algorithm for interpreting arrow symbols in such pen-based systems. Section 2.5 reviews the studies of spatial relations between line segments, which form a foundation for modeling the spatial arrangement of arrow symbols in arrow diagrams.

## 2.1. Definition of Arrow Symbols

*What are arrow symbols?* Arrow symbols are often called *arrows* in short. The term *arrow symbol* emphasizes that it refers to a *symbol* instead of a flying weapon called *arrow*. The *symbol* is a mark or character used as a conventional representation of something (The Concise Oxford Dictionary, 10<sup>th</sup> edition). Arrow symbols are polysemic symbols, representing a large variety of things depending on the context (Section 2.2).

Dictionaries define the arrow (symbol) as follows:

- Something, such as a directional symbol, that is similar to an arrow in form or function (The American Heritage Dictionary of the English Language, 4<sup>th</sup> Edition).
- A sign consisting of a straight line with an upside down V shape at one end of it, which points in a particular direction, and is used to show where something is (Cambridge Advanced Learner's Dictionary).
- Something shaped like an arrow; especially a mark (as on a map or signboard) to indicate a direction (Merriam-Webster Online Dictionary).
- A mark or sign like an arrow, used to show direction or position (Oxford Advanced Lerner's Dictionary).

These definitions commonly point out that the shape of an arrow symbol is similar to an arrow (in the sense of the flying weapon), and that an arrow symbol typically shows a direction or a position of something.

Tversky (2001) defined an arrow symbol as “*a special kind of line, with one end marked, inducing an asymmetry.*” This definition highlights two essential features of arrow symbols: linearity and asymmetry. With these two features, an arrow symbol establishes an affordance (Gibson 1979) to prompt the diagram readers to move their attention from the tail along the body to the head of the arrow symbol. Accordingly, if the arrow symbol connects two elements, these elements are naturally ordered. Also, if the diagram space is mapped onto a physical space, the arrow symbol naturally makes people imagine the movement of something (typically illustrated around the arrow symbol) in this space. Naturally, arrow symbols are related to such image schemata as LINKS and PATHS (Johnson 1987), which are recurring imaginative patterns with which people comprehend and structures their experiences while moving through and interacting.

This thesis basically follows the Tversky’s definition of arrow symbols. This definition, however, implicitly assumes simple arrow symbols, not allowing branching arrow symbols, bidirectional arrow symbols, looped arrow symbols, and lines with  $\Delta$ -shaped marks on them (Figure 2.1). This thesis considers a branching arrow symbol as a pair of partly coexisting arrow symbols and a bi-directional arrow symbol as a pair of fully coexisting arrow symbols with reverse direction. On the other hand, the looped arrow symbols and the lines with  $\Delta$ -shaped marks along them are considered not as arrow symbols, but other type of symbols that consist of a linear body and a directional mark.

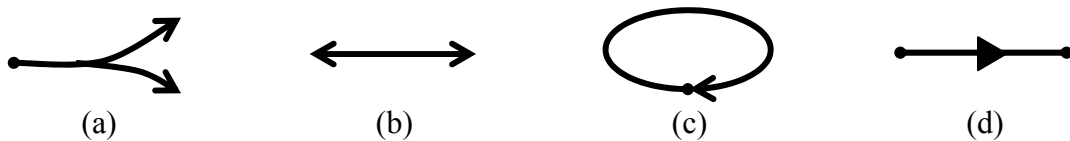

Figure 2.1: Examples of non-simple arrow symbols.

## 2.2. Semantic Roles of Arrow Symbols

*How do people use arrow symbols?* Van der Waarde and Westendorp (2000) found that arrow symbols in user instructions have the following seven usages: direction of a movement, physical change or transformation, indication of a dimension (distance), labeling, focusing the attention, indication of a sequence (order), and a part of designed symbols. Horn (1998) also collected various semantic roles of arrow symbols (Figure 2.2), although his collection looks not exhaustive (for instance, *labeling* is missing), while it contains such an unfamiliar role as *arrow as object moving*.

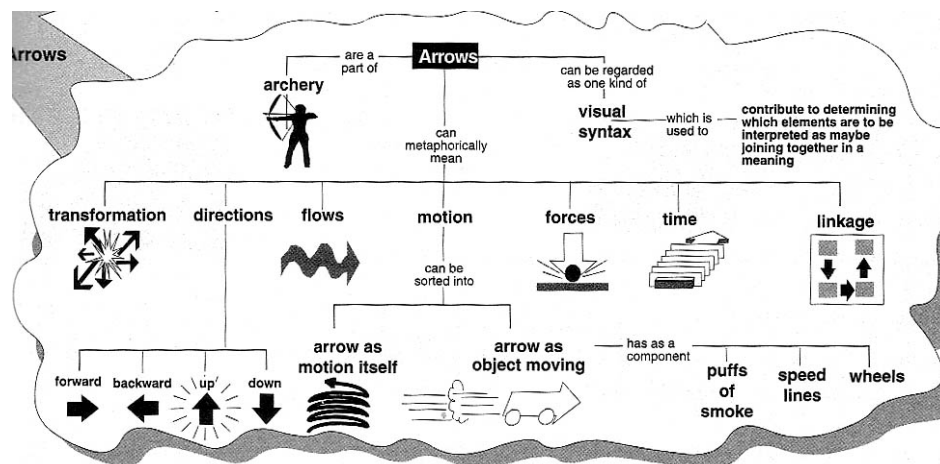

Figure 2.2: A collection of semantic roles of arrow symbols (Horn 1998).

The remainder of this section reviews various usages of arrow symbols in literature. Each usage corresponds to different semantic role. The collected semantic roles are later classified (Section 4.1) and used as a foundation for the interpretation.

### 2.2.1. Specifying a Directional Property

An arrow symbol may be attached to a single element in a diagram. In this case, all visual variables of the arrow symbol, such as length, width, shape, color, direction, and pattern (Bertin 1983), can be controlled by its designer. Among these variables, the length and direction are predominant because of the linearity and asymmetry peculiar to arrow symbols. Accordingly, arrow symbols are potentially suitable for representing properties related to a length, a direction, or both. A length-related property, however, can be more simply represented by a line segment or a bar. Consequently, arrow symbols are preferably used to specify a direction-related property or a property related to both a direction and a length (i.e., *vector*).

Maps with arrow symbols pointing North are found as early as the beginning of the 15th century (Westendorp 2006). As for the directional properties other than the map's North, Gombrich (1990) found the diagram with an arrow symbol specifying the direction of water flow in a channel, dating back to 1737 (Figure 2.3).

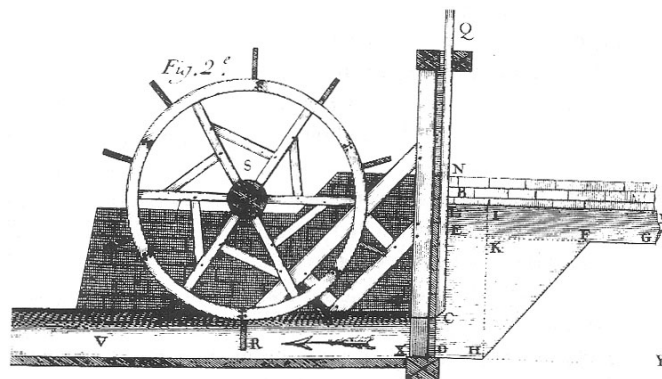
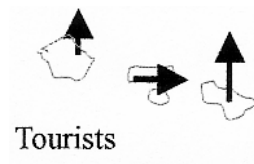
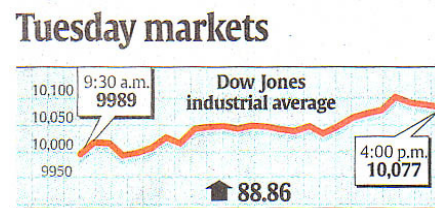

Figure 2.3: The presumably earliest diagram with an arrow symbol used for specifying a directional property other than map's North, drawn in 1737 (Gombrich 1990).

Directions sometimes have metaphorical meanings. Typically, the upward direction is associated with increase or improvement, whereas the downward direction is associated with decrease or debasement (Lakoff and Johnson 1980). Accordingly, upward and downward arrow symbols are used to metaphorically indicate those semantics, respectively. For instance, in Figure 1.1, an upward arrow symbol next to “*Tofu Price*” indicates the rise of tofu price. Figure 2.4 shows two examples in which arrow symbols metaphorically indicate the trend of the tourist numbers and that of a market index, respectively, by their directions. Similarly, major contemporary Internet web browsers, such as Internet Explorer, Firefox, and Opera, adopt the icons of rightward and leftward arrow symbols, which metaphorically indicate the *forward* and *back* operations (i.e., switching to the next and previous pages), respectively.



(a)



(b)

Figure 2.4: Two arrow-containing diagrams, in which each arrow symbol metaphorically indicates increase or stability of a value.

Both directions and vectors can be seen from an object-based view or a field-based view (Chrisman 1978; Peuquet 1984). For example, the direction of water flow can be seen as a property of water (an object) or a property of a certain location in the channel (Figure 2.3). A *vector field* is a field where a property related to a direction and a length varies from place to place. Traditionally, a vector field is visualized by a



diagram with many arrow symbols, called an *arrow plot* (Sanna *et al.* 2000). Garcke *et al.* (2000) developed a visualization technique for simplifying arrow plots by clustering vector fields and assigning only one arrow symbol for each cluster (Figure 2.5).

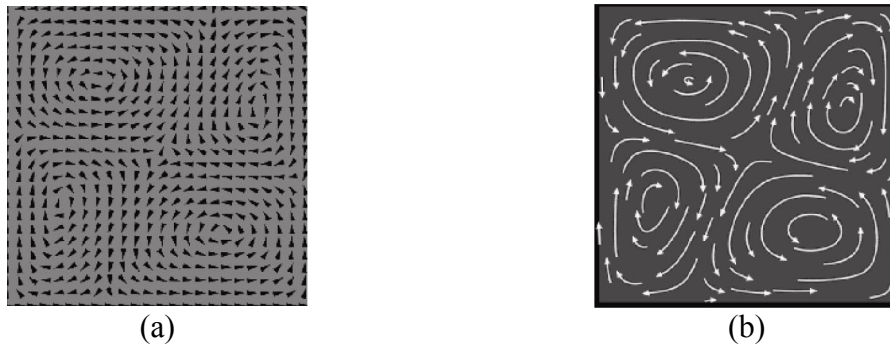

Figure 2.5: Two arrow plots, capturing a vector field (Garcke *et al.* 2000).

### 2.2.2. Illustrating a Spatial Movement

Another traditional semantic role of arrow symbols is to illustrate a spatial movement (and its route). The linearity and asymmetry of arrow symbols are appropriate features for illustrating both route and direction of the spatial movement, respectively. Bertin (1983) claimed that arrow symbols are the most efficient (and often the only) formula for illustrating a complex movement. Westendorp (2006) found that Galileo Galilei's manuscript for his book, *Sidereus Nuncius*, published in 1610, has arrow symbols illustrating the course of movement of Jupiter's moons (Figure 2.6a). Interestingly, the pictorial message mounted to the Pioneer 10 spacecraft (Figure 2.6b) contains a similar arrow symbol illustrating the route of the spacecraft in the solar system, assuming that aliens would understand that the arrow symbol illustrates the route of the spacecraft (Sagan and Sagan 1972).

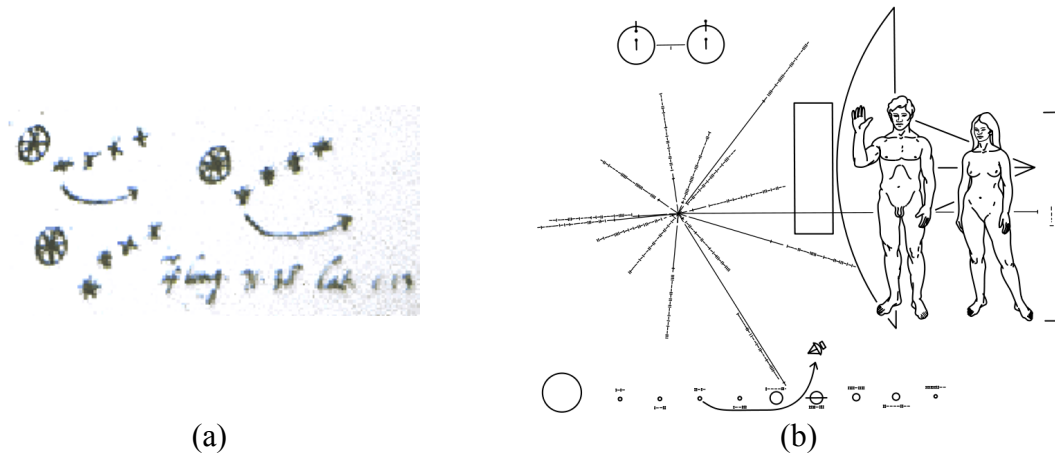

Figure 2.6: (a) A diagram in Galilei's manuscript showing arrow symbols that illustrates the course of movement of Jupiter's moon (Westendorp 2006). (b) The pictorial message mounted to Pioneer 10 spacecraft in which an arrow symbol illustrates the course of movement of the spacecraft (Sagan and Sagan 1972).

An arrow symbol may illustrate not only an individual spatial movement, but also a typical pattern of repeated spatial movements. Monmonier (1990) showed an example where a set of linearly linked arrow symbols captures a typical immigration route of the first settlements in the New York State (Figure 2.7). In a similar way, architects annotate a floor plan with what patterns they anticipate for people or vehicles (Do and Gross 2001).

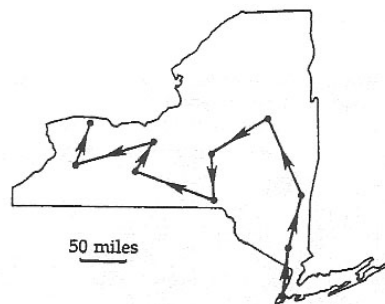
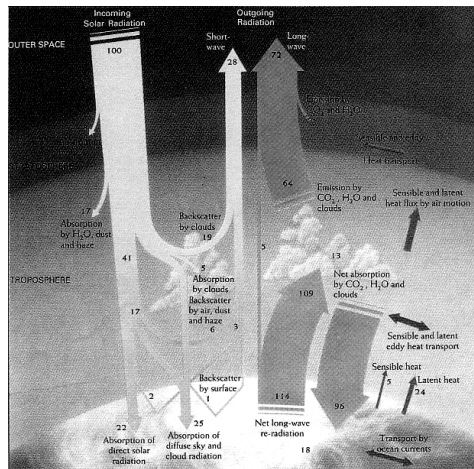

Figure 2.7: Arrow symbol capture a typical immigration route in the New York State (Monmonier 1990).

### 2.2.3. Illustrating Communication

In geography, the flow of people, goods, or services between two locations is typically modeled as the *spatial interaction* of the locations (Bailey and Gatrell 1995). Spatial interactions have attracted much attention from economic geographers, because modeling the scale of spatial interactions contributes to the demand projection of new facilities, such as shopping centers and parking lots. A spatial interaction is essentially an aggregation of spatial movements between two locations. Consequently, an arrow symbol can illustrate a spatial interaction just like a spatial movement, although the route is often abbreviated due to the lack of the drawer's concern. The scale of a spatial interaction is reasonably expressed by the width of the arrow symbol's linear part (Figure 2.8a), since people typically perceive the width of lines without a bias (Robinson *et al.* 1995).

The diagram illustrating spatial interactions easily becomes messy as the number of interacting locations increases (Figure 2.8b). Thus, the cartographic community has made a considerable efforts to visualize spatial interactions effectively (Tobler 1981; 1987; Becker *et al.* 1995). Tobler (1981) visualized a large number of spatial interactions simply by arrow plots (Section 2.2.1), assuming a potential vector field that implies the imbalance of the original data.



(a)

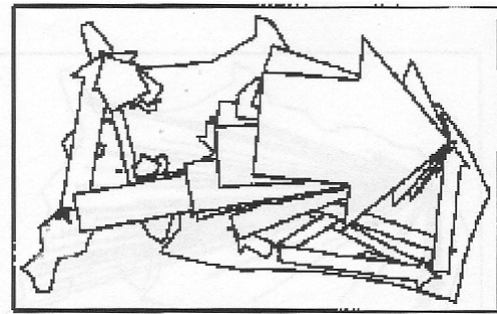

(b)

Figure 2.8: Two arrow-containing diagrams in which each arrow symbol illustrates a spatial interaction and its scale between two locations: (a) Gradel and Crutzen (1995) and (b) Tobler (1987).

An arrow symbol may illustrate an interaction between two locations, as well as between two remote entities. This usage is called *communication*, since the interaction is achieved by the communication of a certain item, such as message and data, from one entity to another entity (Figure 2.9).



Figure 2.9: An arrow symbol illustrating a communication between two objects (Worboys and Duckham 2004).

### 2.2.4. Illustrating Continuous Existence

Timetables and chronological tables often contain arrow symbols, which illustrate that something (for instance, a project or a dynasty) persists over a certain time interval

(Figure 2.10). Arrow symbols illustrating such continuous existence are probably transformed from those illustrating a spatial movement (Section 2.2.2), since persistence over a time interval is considered a travel in time instead of space. Such transformation of a spatial concept into a temporal concept naturally occurs, since people often understand the concept of time with the aid of spatial metaphors (Lakoff and Johnson 1980).

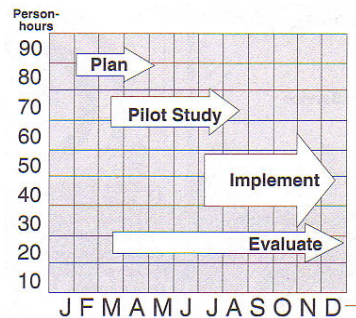

Figure 2.10: A timetable in which each arrow symbol captures continuous existence of a job phase over a time interval (Horn 1998).

### 2.2.5. Indicating a Temporal Order

Flowcharts often contain arrow symbols, each of which indicates a *temporal order* between two components. The connected components may represent:

- two different elements (Figure 2.11a), or
- two different states of the same element (Figure 2.11b).

In the former case, the arrow diagram may imply a *conditional relation* or a *causal relation* between the elements, such that the proceeding element works as a precondition or a cause of the subsequent element. For example, in Figure 1.1, the arrow

symbol connecting “*El Niño*” and “*Fish Catch* ↓” illustrates a causal relation between the El Niño effect (*cause*) and the decrease of fish catch (*result*).

In the latter case, the arrow symbol captures a *change* of the element. A change is an event where an element transforms its property, such as identity, appearance, name, and structure. The studies of event modeling frequently use arrow diagrams for visualizing changes (Claramunt and Theriault 1995; Hornsby and Egenhofer 1997; Claramunt *et al.* 1998; Hornsby and Egenhofer 1998; 2000). For instance, Figure 2.11b illustrates the historical transitions of territories in New England, where each horizontal arrow symbol captures a change of a territory with regard to its presence or absence, while each diagonal arrow symbol captures a change of a land with regard to its territorial attribution.

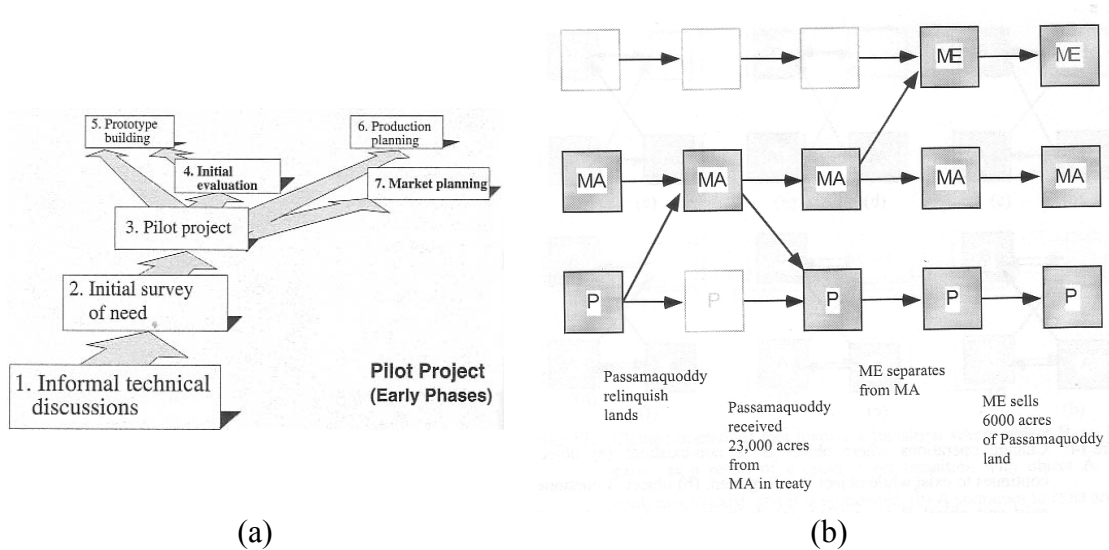

Figure 2.11: Two flowcharts in which each arrow symbol indicates a temporal order: (a) Horn (1998) and (b) Hornsby and Egenhofer (2000).

### 2.2.6. Labeling

A complicated illustration often contains several arrow symbols, each of which assigns a text label to another element. For instance, Figure 2.12 illustrates a computer's hard drive, where arrow symbols are used for labeling its mechanical parts. Alternatively, the labels may be placed directly onto the labeled elements, but such direct placement of labels may mess up the diagram. Line segments also can be used for labeling, but the use of arrow symbols promotes a clear distinction between labels and labeled elements.

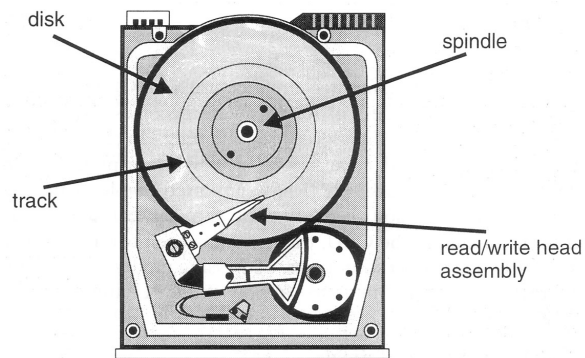

Figure 2.12: An illustration of a computer's hard drive, in which each arrow symbol attaches a text label to a mechanical component of the drive (Worboys and Duckham 2004).

### 2.2.7. Indicating Ordered Binary Relations

The use of arrow symbols to indicate relations is a widespread convention in sketches (Forbus and Usher 2002). Especially, arrow symbols distinctively indicate ordered binary relations (i.e., asymmetric relations between two elements). Ordered binary relations are a broad concept that includes spatial interactions, communications, temporal orders, conditional/causal relations, changes, and labeling. In mathematics, a set of ordered

binary relations within a domain is modeled as a directed graph (Lipschutz and Lipson, 1997), which is often visualized as a multi-arrow diagram (Figure 2.13).

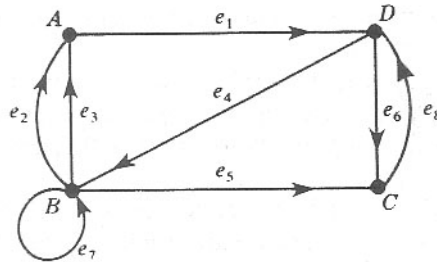

Figure 2.13: A directed graph, in which each arrow symbol captures an ordered binary relation between two elements (Lipschutz and Lipson, 1997).

### 2.3. Characteristics of Arrow Symbols and Diagrams

*Why do people use arrow symbols?* One obvious reason is that arrow symbols have a large variety of semantic roles, regardless of their extremely simple shapes (Section 2.2). This characteristic of arrow symbols enables people to use arrow symbol conveniently and casually. The second reason is that the presence of arrow symbols encourages causal, functional interpretations of a diagram (Tversky *et al.* 2000). Thanks to this characteristic, people can communicate a complicated process or mechanism even in a static diagram. The third reason is that people frequently use diagrams to assist in communication, which naturally leads to the frequent use of arrow symbols.

Why do people frequently use diagrams? A well-known answer is, as seen in a proverb, “*a picture is worth a thousand words*” (Tufte 1990)—that is, graphic representations, including diagrams, convey certain types of information more effectively than verbal expressions. For instance, people often draw a rough map to explain a route,



because rough maps are easier than verbal route descriptions (Agrawala and Stolte 2001). Larkin and Simon (1987) and Cheng *et al.* (1999), however, pointed out that diagrams work effectively *only if* the diagrams' advantages are appropriately exploited; otherwise, diagrams are rather tortuous. Larkin and Simon (1987) further insisted that such an advantage of diagrams lies in the adjacency of elements (i.e., the diagrams' characteristic that related elements are typically located nearby), which reduces the amount of search that is necessary for problem solving.

Larkin and Simon (1987) also highlighted the effect of perceptual inference. People intuitively make inference about parallelism/perpendicular lines, relative positions, similarity under translation, scaling and/or rotation, approximate equivalence of lengths, sizes, and angles, relative size, and proportionality and, therefore, diagrams may reduce cognitive efforts for problem solving by making use of people's outstanding ability of such perceptual inference (Novak 1995).

Another benefit of diagrams is that they can serve as short-term memories for intermediate results (Novak 1995). People progressively annotate a diagram with intermediate results, making those results available when necessary for problem solving. Tversky (2001) demonstrated that externalizing a diagrammatic representation reduces the demand on memory, thereby facilitating information processing.

Stenning and Oberlander (1995) pointed out *specificity* as another advantage of diagrams. They showed that diagrams are less abstract representations than verbal descriptions, reducing the mental load for problem solving and, thereby, enhancing the ability of information processing. Meanwhile, diagrams are used also for illustrating

abstract concepts. People often understand such abstract concepts in terms of spatial metaphors (Lakoff and Johnson 1980). Therefore, diagrams, which bootstrap abstract thought onto spatial thought, facilitate people's understanding of abstract concepts (Tversky 2000).

Pinker (1990) tried to model how people understand diagrams (or *graphs* in his terminology), considering diagrams as a communication medium that conveys conceptual messages. Diagram readers have their own *graph schema*, which is developed through education and experiences. If a diagram suits their graph schema, the readers understand the conceptual message of the diagram almost automatically. Even if the diagram does not suit their graph schema, the readers try to understand the diagram by reasoning. This process, however, requires a heavy mental load, and accordingly people sometimes take a long time or even fail to understand a diagram. In this way, Pinker's model explains the difference of people's abilities to understand diagrams.

These studies pointed out many benefits of diagrams, which explain why people frequently use diagrams. Diagrams are a beneficial and effective tool for human communication; therefore, it is highly desirable for information systems to allow their users to interact with the systems through diagrammatic communications. Actually, many researchers have tried to develop such systems, some of which are reviewed in the next section.

## 2.4. Computational Understanding of Diagrams

*Diagram-understanding systems* are computer systems with a capability of understanding diagrams that the user draws. Through the review of current diagram-understanding systems, this section identifies the goal of diagram understanding technologies and the necessity of a method for interpreting arrow symbol.

### 2.4.1. Current Diagram-Understanding Systems

Over the last ten years, a variety of diagram-understanding systems have been developed, aiming at more natural and effective human-computer interaction. For instance, Aoki *et al.* (1996) developed a system that transforms hand-drawn floor plans into CAD data. Egenhofer and Blaser developed *Spatial-Query-by-Sketch*, which enabled its users to query spatial data by sketching a rough map of a place of interest (Egenhofer 1997; Blaser and Egenhofer 2000). *SketchIT* (Stahovich 1997; Kurtoglu and Stahovich 2002) interprets hand-drawn mechanical drawings and recreates new designs that realize the same functions. Similarly, *ASSIST* (Alvarado and Davis 2001b; 2001a; Davis 2002) interprets hand-drawn mechanical drawings and predicts how the illustrated mechanism would behave (Figure 2.14). Landay and Myers (2001) developed a computer system that supports GUI designs, which interprets hand-drawn screen layouts and generates a prototype program (Figure 2.15). Skubic (2002) built a self-propelled robot, which moves in the real world following a route in a sketch map.

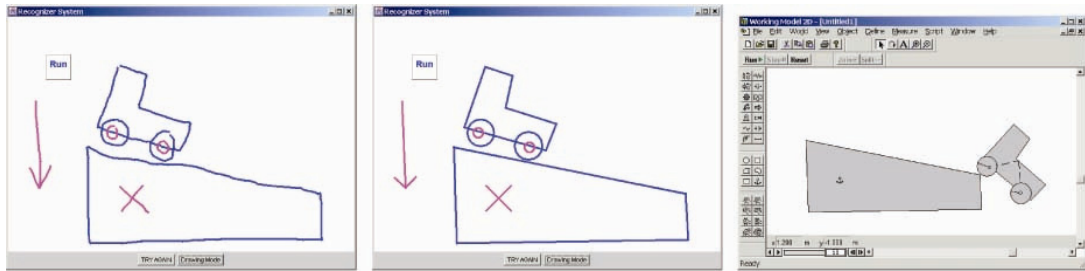

Figure 2.14: ASSIST (Alvarado and Davis 2001b; 2001a; Davis 2002).

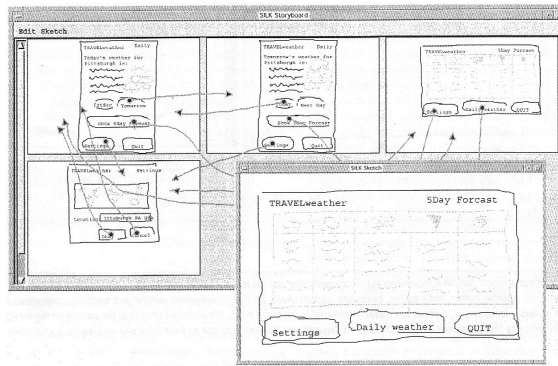

Figure 2.15: A sketch-based system that supports GUI designs (Landay and Myers 2001).

While these systems were designed for specific tasks, *GeoRep* (Ferguson and Forbus 2000) was designed for the understanding of diagrams in various domains, distinguishing the domain-independent lower-level process and the higher-level process using domain-specific rules. Ferguson *et al.* (2000) applied *GeoRep* for the understanding of well-standardized diagrams used in military operations, called *Course of Action (COA)* diagrams. Furthermore, *sKEA* (Ferguson and Forbus 2002; Forbus and Usher 2002) is totally free from the application domains. In this system, the user teaches the computer his or her knowledge of any domain by sketching diagrams (Figure 2.16).

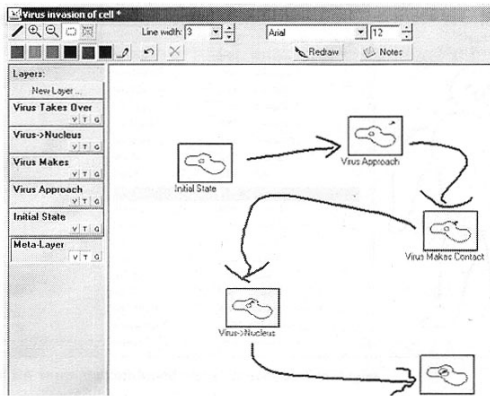

Figure 2.16: sKEA (Ferguson and Forbus 2002; Forbus and Usher 2002).

In addition to the diagram-understanding systems based on sketching interfaces, some researchers combine a sketching interface with a speech interface, aiming at more user-friendly and effective user interaction. For instance, Egenhofer (1996) developed the framework of *Sketch-and-Talk* in GIS, which enables its user to query spatial data by indicating a place of interest by the combination of sketch and speech, which partially overlap with each other and work complementarily (Schlaisich and Egenhofer 2001). *QuickSet* (Cohen *et al.* 1997; Johnston 1998; Cohen *et al.* 2000; Oviatt and Cohen 2000) is a multi-modal system for map-based tasks, which is operated by speech and pen input (Figure 2.17). Based on the experiments with *QuickSet*, Oviatt (1999) pointed out that speech and pen input work complementarily rather than independently and, accordingly, the combination of these two modes improves both input efficiency and recognition rate. Similarly, *nuSketch* (Forbus *et al.* 2001; Ferguson and Forbus 2002) is a multi-modal system operated by sketch and speech. This system is based on *GeoRep* (Ferguson and Forbus 2000) and also applied to the *COA diagrams* (Figure 2.18). With speech input, *nuSketch* avoids the problems in recognizing objects (glyphs), which may be rapidly

drawn and then classified via a few quick verbal comments rather than carefully drawn in detail (Ferguson and Forbus 2002). *ASSISTANCE* (Davis 2002) is another multi-modal system that facilitates mechanical designs with sketch and verbal input.

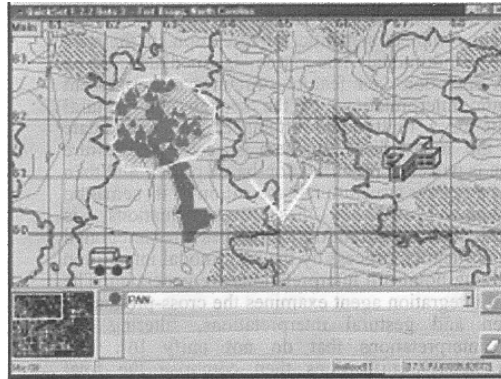

Figure 2.17: QuickSet (Cohen *et al.* 1997; Johnston 1998; Cohen *et al.* 2000; Oviatt and Cohen 2000).

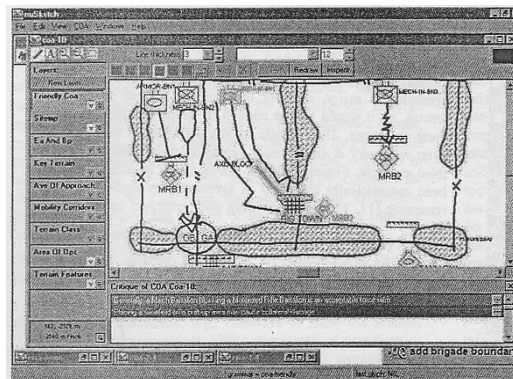

Figure 2.18: nuSketch COA creator (Forbus *et al.* 2001; Ferguson and Forbus 2002).

## 2.4.2. What is Diagram Understanding?

A comparison of these diagram-understanding systems reveals three different levels of computational diagram understanding. At the most primitive level, diagram understanding is equivalent to a set of symbol recognition processes. For example, the

floor plan interpreter (Aoki *et al.* 1996) recognizes such architectural symbols as walls, doors, and windows individually, using a collection of templates for those architectural symbols. This level of diagram understanding is relatively easy, as it is achieved by preparing a sufficient set of templates for the target domain (Davis 2002).

The difficulty of such symbol recognition arises when the system has to handle polysemic symbols, such as zigzag symbols in mechanical drawings, which may represent a spring or an electrical resistor (Kurtoglu and Stahovich 2002). Interpretation of such ambiguous symbols requires the consideration of plausible relations between the entities represented by the symbols (Davis 2002; Kurtoglu and Stahovich 2002). For instance, a zigzag symbol that connects to a battery symbol probably represents an electrical resistor, because a battery can be connected to an electrical resistor, but rarely to a spring. In this way, background knowledge about plausible relations among the elements in the target domain is necessary for the diagram understanding in the middle level.

The highest level of diagram understanding further requires the understanding of the overall mechanism or process that the diagram illustrates. At this level, diagram understanding is no longer a passive process of absorbing what is in the diagram, but an active process of model construction and inference, using the diagram as an outline of the model to be constructed (Novak 1995). If a diagram-understanding system achieves this level, the system can predict how each element in the diagram would behave in the real world (Funt 1980; Davis 2002) or even redesign the mechanism that satisfies the same functions (Stahovich 1997).

Interpretation of arrow-containing diagrams corresponds to the middle-level diagram understanding, because arrow symbols are polysemic. Like zigzag symbols, the interpretation of arrow symbols may have to consider the plausible relations between the components. In addition, the interpretation of arrow symbols is critical for the highest-level diagram understanding, since arrow symbols are often used for the illustration of complicated processes or mechanisms.

### **2.4.3. Diagram-Understanding Systems and Arrow Symbols**

Many of the diagram-understanding systems accept the use of arrow symbols. In some systems, however, the use of arrow symbols is restricted to a single or a few predetermined semantic roles. For instance, in the GUI design support system (Landay and Myers 2001) arrow symbols are used only for specifying which window emerges or gets focus when each GUI component is operated (Figure 2.15). In SketchIT (Stahovich 1997; Kurtoglu and Stahovich 2002), arrow symbols are used only for specifying the directions in which mechanical components can move. In ASSIST (Alvarado and Davis 2001b; 2001a; Davis 2002) the user can use an arrow symbol to specify the gravity direction (Figure 2.14). In nuSketch COA creator (Forbus *et al.* 2001; Ferguson and Forbus 2002) arrow symbols with different semantic roles are distinguished by their different shapes. Such restriction of arrow symbols to a few semantic roles works effectively for specific tasks, since the ambiguity of arrow symbols are excluded. As a drawback, the users of these systems are forced to get used to the restriction of arrow symbols, which sacrifices the intuitiveness of sketching interfaces.



QuickSet (Cohen *et al.* 1997; Johnston 1998; Cohen *et al.* 2000; Oviatt and Cohen 2000) accepts arrow symbols with a variety of semantic roles, such as specifying a direction, illustrating a route, and indicating relations (Figure 2.17). Furthermore, sKEA (Ferguson and Forbus 2002; Forbus and Usher 2002) allows its users to express arbitrary binary relations using arrow symbols (Figure 2.16). These systems, however, still have room for improvement, because the users have to specify the semantic role of every arrow symbol by speech (QuickSet), text input, or selection from a menu (sKEA). Such specification disturbs human-computer interactions, because in human communications arrow symbols are communicated smoothly without specification.

Overall, most current diagram-understanding systems do not allow the natural use of arrow symbols, due to the lack of a human-like ability to understand the semantic roles of arrow symbols. One exception is ASSISTANCE (Davis 2002), which automatically distinguishes the arrow symbols representing causality and those representing external force. Such distinction, however, depends on the domain-specific rules, which cannot be applied to other sketch-based tasks. The remainder of this thesis, therefore, develops a general-purpose algorithm for deriving the interpretations of arrow symbols in diagrams, aiming at the improvement of sketching interfaces.

## **2.5. Spatial Relations between Line Segments**

In multi-arrow diagrams, a set of arrow symbols in a specific formation may organize a group and jointly capture certain semantics, such as expansion and multiple choices

(Figure 1.2). This motivates us to model the spatial arrangement of arrow symbols in multi-arrow diagrams (Section 3.3). As the foundation of this model, this section reviews the studies of spatial relations between (directed) line segments.

Topological relations are spatial relations invariant under topological transformations, such as translation, rotation, and scaling (Egenhofer 1989). Topological relations between line segments in  $\mathbf{R}^2$  (and their lower-dimensional relatives, temporal intervals in  $\mathbf{R}^1$ ) have been studied extensively in artificial intelligence and spatio-temporal databases communities.

The *4-intersection* (Egenhofer and Franzosa 1991) captures topological relations between two spatial objects, including line segments, based on the presence or absence of geometric intersections of the objects' interiors and boundaries. The topological relations between two objects<sup>1</sup>  $A$  and  $B$  are characterized by the patterns of the *4-intersection matrix* (Equation 1) with regard to the emptiness or non-emptiness of each entry, where  $X^\circ$  and  $\partial X$  refer to the interior and boundary of an object  $X$ , respectively.

$$M(A, B) = \begin{pmatrix} A^\circ \cap B^\circ & A^\circ \cap \partial B \\ \partial A \cap B^\circ & \partial A \cap \partial B \end{pmatrix} \quad (1)$$

The 4-intersection distinguishes eight topological relations between two line segments embedded in  $\mathbf{R}^1$  (Pullar and Egenhofer 1988) and sixteen relations between two

---

<sup>1</sup> Capitalized letters are used for representing individual spatial objects, since these objects are originally defined as point sets Alexandroff, P. (1961) *Elementary Concepts of Topology*. Dover, Mineola, NY.

line segments embedded in  $\mathbf{R}^2$  (Hadzilacos and Tryfona 1992). The dimension-extended method of the 4-intersection (Clementini *et al.* 1993) finds eighteen relations between two line segments embedded in  $\mathbf{R}^2$ .

The *9-intersection* (Egenhofer and Herring 1991) extends the 4-intersection by considering also the intersections with respect to the objects' exteriors, which gives rise to distinguishing 33 topological relations between two line segments embedded in  $\mathbf{R}^2$  (Egenhofer 1994). Another variation of the 4-intersection distinguishes explicitly the two distinct elements of line segments' boundaries—the start point and the end point—and identifies 16 relations between uni-directed line segments embedded in a cyclic one-dimensional space (Hornsby *et al.* 1999) and 68 relations between two directed line segments embedded in  $\mathbf{R}^2$  (Kurata and Egenhofer 2006a). In this model, the topological relations between two line segments<sup>1</sup>  $L_1$  and  $L_2$  are characterized by the patterns of a  $3 \times 3$  matrix (Equation 2) with regard to the emptiness or non-emptiness of each entry, where  $\partial_s L$ ,  $L^\circ$  and  $\partial_e L$  refer to the start point, interior, and end point of a directed line segment  $L$ , respectively.

$$M(L_1, L_2) = \begin{pmatrix} \partial_s L_1 \cap \partial_s L_2 & \partial_s L_1^\circ \cap L_2^\circ & \partial_s L_1 \cap \partial_e L_2 \\ L_1^\circ \cap \partial_s L_2 & L_1^\circ \cap L_2^\circ & L_1^\circ \cap \partial_e L_2 \\ \partial_e L_1 \cap \partial_s L_2 & \partial_e L_1 \cap L_2^\circ & \partial_e L_1 \cap \partial_e L_2 \end{pmatrix} \quad (2)$$

Models for more detailed topological relations, capturing such properties of non-empty intersections as the number of intersections and the dimension of common parts, have been developed for topological relations between two regions (Egenhofer and Franzosa 1995) and two line segments (Clementini and Di Felice 1998), yielding a set of

*topological invariants*. Such additional invariants have been known to be tightly related to distinguishing even basic relations between line segments, such as *touching* and *crossing* (Herring 1991). Furthermore, Nedas *et al.* (2007) captured more details of topological relations between line segments by incorporating two metric measures, splitting ratios and closeness measures, into the 9-intersection matrix.

Other approaches categorize spatial relations between line segments based on the order of the line segments. Allen (1983) identified thirteen order relations between two temporal intervals (essentially uni-directed line segments in  $\mathbf{R}^1$ ). Schlieder (1995) extended the concept of order into a two-dimensional space and identified 63 two-dimensional order relations (essentially directional relations) between two straight directed line segments embedded in  $\mathbf{R}^2$ . The *dipole calculus* (Moratz *et al.* 2000) distinguished 24 directional relations between two straight directed line segments embedded in  $\mathbf{R}^2$ , which fulfill the constraints of a relation algebra. Likewise, a set of 26 order relations between two directed line segments in  $\mathbf{R}^1$  forms the *directed interval algebra* (Renz 2001). The *direction-relation matrix* provides an overall framework for describing directional relations between any pair of extended objects in  $\mathbf{R}^2$ , including arbitrarily shaped line segments (Goyal and Egenhofer 2000).

## 2.6. Summary

This section reviewed the related studies about the characteristics and semantic roles of arrow symbols, diagram-understanding computer systems, and spatial relations between line segments. The major findings are summarized as follows:

- An arrow symbol is defined as a special kind of line, with one end marked, inducing an asymmetry.
- Arrow symbols are used multi-purposely for specifying a directional property, illustrating a spatial movement, communication, and continuous existence, indicating an ordered binary relation (including temporal orders, changes, causal relations, and conditional relations), and labeling.
- Diagrams facilitate the communication of information as well as enhance people's ability for problem solving. To make use of such diagrams' strength, a number of pen-based systems that understand human-sketched diagrams have been developed, aiming at more user-friendly and effective computer interfaces.
- To realize more intelligent interfaces, diagram-understanding systems should be equipped with a capability to interpret the arrow symbols in the diagrams.
- Topological relations between two directed line segments, which forms a foundation for modeling the spatial arrangement of arrow symbols, are modeled systematically based on the presence or absence of geometric intersections of the three parts (start point, interior, and end point) of the two segments.

## Chapter 3

### STRUCTURES OF ARROW DIAGRAMS

Pen-based systems should be able to distinguish the semantic roles of arrow symbols, since people use arrow symbols multi-purposely without specification (Section 2.2). Thus, this thesis develops an algorithm for deducing the semantic roles of arrow symbols, which is called the *ASI* (arrow symbol interpreter). This method emphasizes the structural patterns of arrow diagrams, which apparently have a strong influence on the diagrams' semantics (Section 1.1). As the foundation, this chapter introduces two types of structures of arrow diagrams, called *individual structures* and *inter-arrow structures* (Kurata and Egenhofer 2005a; 2005b; 2006c). Individual structures model the spatial arrangement of components around individual arrow symbols, while the inter-arrow structures model the spatial arrangement of multiple arrow symbols in arrow diagrams. These two types of structures work complementarily, because they capture the configurations of arrow diagrams from local and global perspectives.

This chapter first introduces relevant terminology (Section 3.1). Then, Section 3.2 and Section 3.3 define the individual structures and the inter-arrow structures, respectively. Section 3.4 demonstrates through two examples how these two types of structures work complementarily.

### 3.1. Terminology

An *arrow diagram* is a syntactic unit in a diagram, which consists of arrow symbols and the elements to which the arrow symbols refer, called the *components* of the arrow diagram (Section 1.2). Each component is considered an independent semantic unit that contributes to the diagram's semantics. Components are typically illustrated around the arrow symbols by an icon, text, a small diagram embedded in the arrow diagram, or a specific point or region in the background picture, map, or image. Sometimes components are separate from the arrow symbols or even not illustrated in the diagram (Section 6.5.1).

A *1-arrow diagram* contains a single arrow symbol, while a *multi-arrow diagram* contains more than one arrow symbol. The semantics of the 1-arrow diagram is established by an arrow symbol and its components (Chapter 4). Thus, this thesis considers the spatial arrangement of the components around the arrow symbol, which is modeled as an *individual structure* (Section 3.2). In a multi-arrow diagram, such individual structure is associated with every arrow symbol in the diagram. In addition, a set of arrow symbols, typically forming a certain spatial arrangement, may organize a group and jointly capture certain semantics (Section 5.2). Thus, this thesis also considers the spatial arrangement of multiple arrow symbols, which is modeled as an *inter-arrow structure* (Section 3.3).

## 3.2. Individual Structures

The *individual structure* of an arrow symbol models the spatial arrangement of components related to this arrow symbol. This section defines the individual structure and its patterns, introducing the notion of three component slots and the categorization of components.

### 3.2.1. Three Component Slots

When an arrow symbol refers to a component around the arrow symbol, this component is located in front of, behind, or along the arrow symbols to which the component refers. This thesis, therefore, considers that an arrow symbol is a deictic reference frame (Retz-Schmidt 1988), which identifies three different conceptual areas where the components related to this arrow symbol can be located (Figure 3.1). These three areas are called the *component slots* of an arrow symbol and the component slots behind, along, and in front of the arrow symbol are called the *tail slot*, *body slot*, and *head slot*, respectively (Kurata and Egenhofer 2005a).

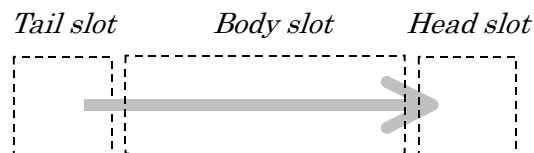

Figure 3.1: Three component slots associated with an arrow symbol.

Each component slot may contain zero, one, or multiple components (Figure 3.2). Every component, if illustrated around an arrow symbol, is assigned uniquely to one



of the three component slots, thereby making the distinction of *tail components*, *body components*, and *head components*.

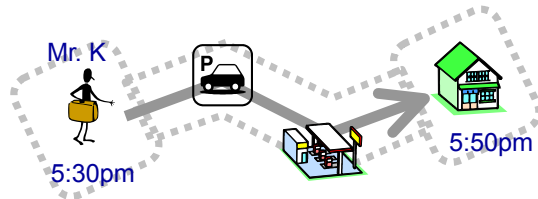

Figure 3.2: An arrow symbol with multiple components in each component slot.

In addition, it is assumed that even if an arrow symbol implicitly refers to a component without pointing to, originating from, or passing by or through it, this component is assigned to one of the arrow symbol's three component slots (Figure 3.3).

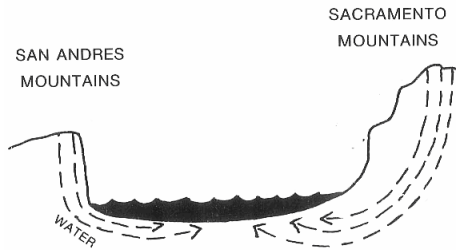

Figure 3.3: The label “*WATER*” is attached to only one of the dashed arrow symbols, but is conceptually assigned to the body slot of all dashed arrow symbols.

### 3.2.2. Definition of Individual Structures

The individual structure associated with an arrow symbol  $a$  (or simply called  $a$ 's individual structure),  $s_{\text{ind}}(a)$ , is defined as a list of the components in  $a$ 's three component slots. It is denoted by a 3-tuple in Equation 3, where  $C_{\text{tail}}(a)$ ,  $C_{\text{body}}(a)$ , and  $C_{\text{head}}(a)$  are the respective non-ordered sets of components in  $a$ 's tail, body, and head

slots. For instance, the individual structure associated with the arrow symbol in Figure 3.2 is  $(\{\text{“Mr. K”, traveler, “5:30pm”}\}, \{\text{parking lot, gas station}\}, \{\text{house, “5:50pm”}\})$ .

$$s_{\text{ind}}(a) = (C_{\text{tail}}(a), C_{\text{body}}(a), C_{\text{head}}(a)) \quad (3)$$

An individual structure captures the spatial arrangement of components in a primitive way, but such arrangement is critical for the diagram’s semantics (Kurata and Egenhofer 2005a). For example, Figure 3.4a shows two 1-arrow diagrams in which the tail component and the head component have been exchanged, essentially reversing the semantics from “*mounting a wheel to a car*” to “*removing a wheel from a car.*” Figure 3.4b shows another pair of 1-arrow diagrams where the head component has been moved to the body slot, such that the semantics changes from “*a tourist goes to Maine*” to “*a tourist passes through Maine.*”



Figure 3.4: Two pairs of 1-arrow diagrams, each with the same components in different component slots, illustrate different semantics.

### 3.2.3. Pattern of Individual Structures

The individual structures have countless configurations, since arrow symbols may refer to arbitrary components. Thus, this thesis extracts fundamental patterns of the individual structures by categorizing the components.

First, components are dichotomized into *primary component (PC)* and *modifier components (MC)*. A primary component represents an independent concept, while a modifier component modifies something else, such as a primary component and an arrow symbol. For instance, in Figure 3.5, the icons for traveler and firework are primary components that represent a traveler and a firework show, while the labels “*Mr. K*”, “*July 4*”, and “*Boston*” are modifier components, which modify the traveler icon, the arrow symbol, and the firework icon, respectively.

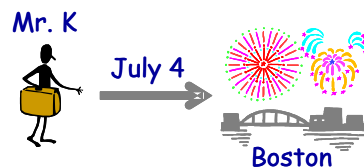

Figure 3.5: A 1-arrow diagram with two primary components (a tourist icon and a firework icon) and three modifier components (“*Mr. K*”, “*July 4*”, and “*Boston*”).

A component has such a representation style as an icon, a text label, a small diagram embedded in the diagram, or a point or region in the background picture, map, or image. The dichotomization of components is, however, purely conceptual and not determined by the representation style of components alone. Therefore, both primary components and modifier components may be expressed by any representation style.

There are, however, the following diagrammatic conventions and rules, which are useful for distinguishing the primary and modifier components in a visual domain:

- Icons are usually primary components;
- Text labels attached to icons are usually modifier components;
- If an arrow symbol refers to only one component, it is always the primary component; and
- Any representation style of a component, if used alone at the head slot, is always a primary component, because the modifier component can be used alone in the tail slot as a label in *annotation* (Section 4.2.3) or in the body slot as an *adverbial component* (Section 4.3.2), but not in the head slot.

In addition to the distinction of primary and modifier components, the primary components are further categorized into the following four types:

- A *location* is a position in space. It is a point or a homogeneous area that is considered as a unit of space (e.g., the parking lot, the gas station, and the house in Figure 3.2). A modifier component may also represent a position in space (e.g., “*Boston*” in Figure 3.5), but it is not included in the location.
- A *moment* is a position in time. It is an instant or a homogeneous interval that is considered a unit of time (e.g., “*5:50pm*” in Figure 3.2). A modifier component may also represent a position in time (e.g., “*July 4*” in Figure 3.5), but it is not included in the location.

- *An object* is an entity or its unit, which exists in physical or conceptual space, and takes an action (e.g., a traveler in Figure 3.5) or gets manipulated (e.g., a wheel and a vehicle without a wheel in Figure 3.4b). Objects are continuants, which endure through some extended interval of time (Worboys and Hornsby 2004).
- *An event* occurs in time. It is characterized by a set of changes that the event triggers. An event occurs at an instant or over an interval (e.g., a firework show in Figure 3.5). Events are occurrents, which happen and are then gone (Worboys and Hornsby 2004).

Location, moment, object, and event are symbolically expressed by  $PC_L$ ,  $PC_M$ ,  $PC_O$ , and  $PC_E$ , respectively, emphasizing that they are subcategories of primary components ( $PC$ ).

The component types may depend on the context. For instance, in Figures 3.6a-b the same icons pointed by the arrow symbols refer to an object (a broken car) and an event (a car accident), respectively. This implies that a method for determining the component types is necessary for fully automated interpretation, but at this stage we assume that the type of every component is given.

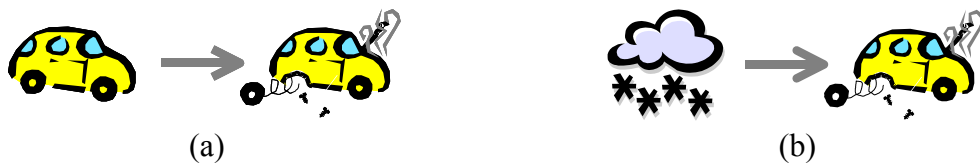

Figure 3.6: Two 1-arrow diagrams, whose head components are apparently same, but belong to different component types: (a) object (a broken car) and (b) event (a car accident).

The influence of the component types on the diagram's semantics is highlighted in the following example (Kurata and Egenhofer 2005a). The arrow symbols

in Figures 3.7a-c originate from the same tourist, but point to different components: (a) a bag (an object), (b) a symposium (an event), and (c) the State of Maine (a location). These different types of components lead to different semantics: (a) the tourist *holds out* his bag, (b) the tourist *attends* the symposium, and (c) the tourist *goes to* Maine. On the other hand, arrow diagrams with the same patterns of component types often lead to similar type of semantics. For example, both Figures 3.7c and 3.7d illustrate a spatial movement of the tail component (an object) to the head component (a location).

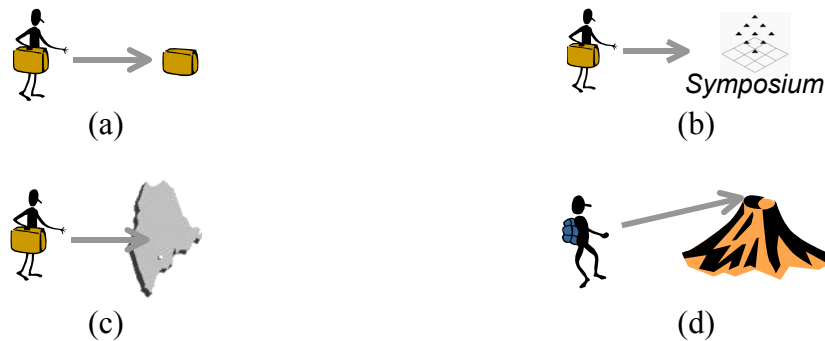

Figure 3.7: Arrow symbols with the same tail components and different types of head components: (a) object, (b) an event, and (c-d) a location.

With the distinction of primary and modifier components ( $PC$  and  $MC$ ), and further distinction of four subclasses of the primary components ( $PC_L$ ,  $PC_M$ ,  $PC_O$ , and  $PC_E$ ), the pattern of the individual structure is defined as follows:

```

pattern_of_individual_structure ::=
    "(" tail_components "," body_components "," head_components ")"
tail_components ::= [components]
body_components ::= [components]
head_components ::= [components]
components ::= component [components]
component ::= PCL | PCM | PCO | PCE | MC

```

For instance, the patterns of the individual structures in Figures 3.8a-d are  $(-, -, -)$ ,  $(PC_O, -, PC_L)$ ,  $(PC_L PC_O, -, -)^2$ , and  $(MC, PC_O, PC_L)$ , respectively. The three elements in each 3-tuple indicate the type of all components in the tail, body, and head slots.

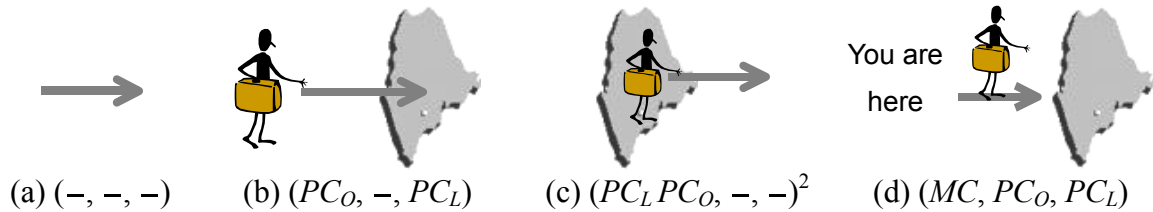

Figure 3.8: Four 1-arrow diagrams with the patterns of their individual structures.

### 3.3. Inter-Arrow Structures

*Inter-arrow structure* models the spatial arrangement of arrow symbols in a multi-arrow diagram. Such arrangement is captured as a set of spatial relations between all pairs of the arrow symbols. Among several types of spatial relations, this thesis focuses on the topological relations, since topological information is highly influential in people's conceptualizations of space (Egenhofer and Mark 1995) and accordingly is expected to play an important role for the diagrams' semantics.

---

<sup>2</sup> This pattern may be described as  $(PC_O PC_L, -, -)$  as well, since the notation of the individual structure is not concerned with the order of components within a slot.

### 3.3.1. Definition of Inter-Arrow Structures

The inter-arrow structure of an arrow diagram  $d$ ,  $s_{\text{int}}(d)$ , is defined as the set of topological relations between all pairs of arrow symbols in  $d$  (Equation 4), where  $M_L(a_i, a_j)$  is the 9-link matrices (Section 3.3.2) of two arrow symbols  $a_i$  and  $a_j$ , which captures their topological relations, and  $A(d)$  is the set of all arrow symbols in  $d$ .

$$s_{\text{int}}(d) = \{M_L(a_i, a_j) \mid a_i, a_j \in A(d), a_i \neq a_j\} \quad (4)$$

### 3.3.2. Topological Relations between Two Arrow Symbols

Topological relations between two arrow symbols are established by the geometric intersections of the arrow symbols (Figures 3.9a and 3.9d), as well as the arrow symbols' references to the same component(s) (Figures 3.9b and 3.9e). To contrast these two types of connections between arrow symbols, a geometric intersection of two arrow symbols is called a *direct link*, while a connection intermediated by a component to which both arrow symbols refer is called an *indirect link* (Kurata and Egenhofer 2006c). Two arrow symbols may be connected by direct links (Figures 3.9a and 3.9d), indirect links (Figures 3.9b and 3.9e), or both direct and indirect links (Figures 3.9c and 3.9f).



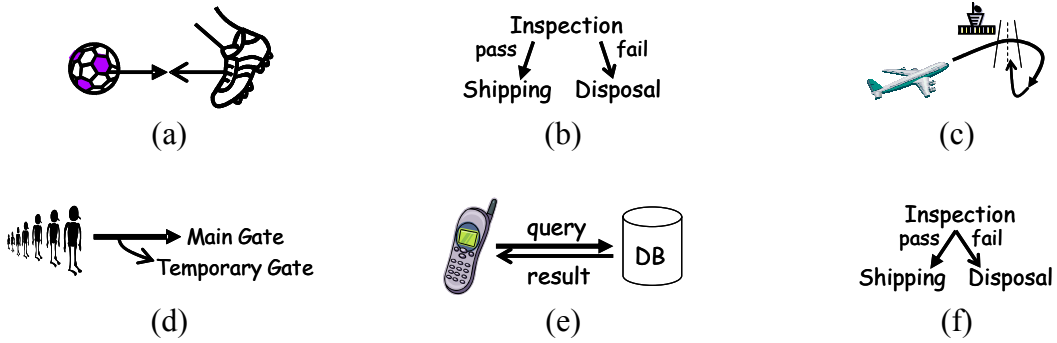

Figure 3.9: Six 2-arrow diagrams where arrow symbols are connected by (a) a head-head intersection, (b) references to the same “*Inspection*” label, (c) both a head-tail intersection and references to the same *landing strip* icon, (d) a body-tail intersection, (e) references to the same *cell phone* and *database* icons, and (f) both a tail-tail intersection and references to the same “*Inspection*” label.

From a geometric viewpoint, topological relations between arrow symbols established by their direct links are equivalent to topological relations between two directed line segments (Section 2.5). The topological relations between two directed line segments are captured based on the presence or absence of geometric intersections of their three parts—*tail* (start point), *body* (interior), and *head* (end point) (Kurata and Egenhofer 2006a). Similarly, this thesis distinguishes three parts of arrow symbols—back end, interior, front end—which are called the *tail*, the *body*, and the *head* of the arrow symbol, respectively. The tail and head are treated as points, while the body is considered an open-ended line segment. Depending on the combination of the intersecting parts,  $3 \times 3 = 9$  types of direct links between two arrow symbols are distinguished: direct *tail-tail*, *tail-body*, *tail-head*, *body-tail*, *body-body*, *body-head*, *head-tail*, *head-body*, and *head-head* links. These nine types of direct links between two arrow symbols  $a_1$  and  $a_2$  are concisely represented by a  $3 \times 3$  matrix (Equation 5), where  $\partial_{\text{tail}} a_k$ ,  $a_k^\circ$ , and  $\partial_{\text{head}} a_k$

are the tail, body, and head of an arrow symbol  $a_k$ , respectively. This matrix corresponds to the *hbt-matrix* (Kurata and Egenhofer 2006a), which distinguishes 68 topological relations between two directed line segments.

$$M_{DL}(a_1, a_2) = \begin{pmatrix} \partial_{\text{tail}} a_1 \cap \partial_{\text{tail}} a_2 & \partial_{\text{tail}} a_1 \circ \cap a_2^\circ & \partial_{\text{tail}} a_1 \cap \partial_{\text{head}} a_2 \\ a_1^\circ \cap \partial_{\text{tail}} a_2 & a_1^\circ \cap a_2^\circ & a_1^\circ \cap \partial_{\text{head}} a_2 \\ \partial_{\text{head}} a_1 \cap \partial_{\text{tail}} a_2 & \partial_{\text{head}} a_1 \cap a_2^\circ & \partial_{\text{head}} a_1 \cap \partial_{\text{head}} a_2 \end{pmatrix} \quad (5)$$

Similarly,  $3 \times 3 = 9$  types of indirect links are distinguished by the combination of the component slots that contain the component to which both arrow symbols refer. These nine types of indirect links are called indirect *tail-tail*, *tail-body*, *tail-head*, *body-tail*, *body-body*, *body-head*, *head-tail*, *head-body*, and *head-head* links. The nine types of indirect links between two arrow symbols  $a_1$  and  $a_2$  are concisely represented by another  $3 \times 3$  matrix (Equation 6), where  $C_{\text{tail}}(a_k)$ ,  $C_{\text{body}}(a_k)$ , and  $C_{\text{head}}(a_k)$  are the respective sets of all components in the tail, body, and head slot of an arrow symbol  $a_k$ .

$$M_{IL}(a_1, a_2) = \begin{pmatrix} C_{\text{tail}}(a_1) \cap C_{\text{tail}}(a_2) & C_{\text{tail}}(a_1) \cap C_{\text{body}}(a_2) & C_{\text{tail}}(a_1) \cap C_{\text{head}}(a_2) \\ C_{\text{body}}(a_1) \cap C_{\text{tail}}(a_2) & C_{\text{body}}(a_1) \cap C_{\text{body}}(a_2) & C_{\text{body}}(a_1) \cap C_{\text{head}}(a_2) \\ C_{\text{head}}(a_1) \cap C_{\text{tail}}(a_2) & C_{\text{head}}(a_1) \cap C_{\text{body}}(a_2) & C_{\text{head}}(a_1) \cap C_{\text{head}}(a_2) \end{pmatrix} \quad (6)$$

Topological relations between arrow symbols are established by direct links, indirect links, and their combinations. Direct links and indirect links are analogous in the sense that both associate two arrow symbols by connecting the tail, body, or head of one arrow symbol with the tail, body, or head of another arrow symbol. Due to this analogy, the presence or absence of the nine types of direct links and the nine types of indirect

links between two arrow symbols  $a_1$  and  $a_2$  is concisely represented by a single  $3 \times 3$  matrix called the *9-link matrix*  $M_L(a_1, a_2)$  (Equation 7), where  $m_{DL\ ij}$  and  $m_{IL\ ij}$  are the  $(i, j)$  elements of  $M_{DL\ ij}(a_1, a_2)$  (Equation 5) and  $M_{IL\ ij}(a_1, a_2)$  (Equation 6), respectively.

$$M_L(a_1, a_2) = [m_{L\ ij}]$$

$$m_{L\ ij} = \begin{cases} \phi & \text{if } m_{DL\ ij} = \phi \quad \wedge \quad m_{IL\ ij} = \phi \\ D & \text{if } m_{DL\ ij} = \neg\phi \quad \wedge \quad m_{IL\ ij} = \phi \\ I & \text{if } m_{DL\ ij} = \phi \quad \wedge \quad m_{IL\ ij} = \neg\phi \\ D \& I & \text{if } m_{DL\ ij} = \neg\phi \quad \wedge \quad m_{IL\ ij} = \neg\phi \end{cases} \quad (i, j = \{1, 2, 3\}) \quad (7)$$

The first, second, and third row of the 9-link matrix correspond to  $a_1$ 's tail, body, and head, while the first, second, and third columns correspond to  $a_2$ 's tail, body, and head, respectively. Each cell specifies the presence of direct ( $D$ ), indirect ( $I$ ), or mixed ( $D \& I$ ) links. Figure 3.10 shows the 9-link matrices for the topological relations between the pairs of arrow symbols in Figure 3.9.

$$\begin{matrix} \begin{bmatrix} \phi & \phi & \phi \\ \phi & \phi & \phi \\ \phi & \phi & D \end{bmatrix} & \begin{bmatrix} \phi & \phi & \phi \\ D & \phi & \phi \\ \phi & \phi & \phi \end{bmatrix} & \begin{bmatrix} I & \phi & \phi \\ \phi & \phi & \phi \\ \phi & \phi & \phi \end{bmatrix} & \begin{bmatrix} \phi & \phi & I \\ \phi & \phi & \phi \\ I & \phi & \phi \end{bmatrix} & \begin{bmatrix} \phi & \phi & D \\ \phi & \phi & \phi \\ \phi & I & \phi \end{bmatrix} & \begin{bmatrix} B & \phi & \phi \\ \phi & \phi & \phi \\ \phi & \phi & \phi \end{bmatrix} \\ \text{(a)} & \text{(b)} & \text{(c)} & \text{(d)} & \text{(e)} & \text{(f)} \end{matrix}$$

Figure 3.10: The 9-link matrices that capture the topological relations between the pairs of arrow symbols in Figures 3.9a-f.

The 9-link matrix distinguishes  $4^9 = 262,144$  patterns, since its nine entries are four-valued ( $\phi, D, I, D \& I$ ). Not all of these patterns, however, correspond to actual topological relations between two arrow symbols, due to the following conditions on the topological relations:

- The head of an arrow symbol cannot intersect with more than one part of another arrow symbol, because the head is a single point. Similarly, the tail of an arrow symbol cannot intersect with more than one part of another arrow symbol.
- If the head slot of an arrow symbol contains multiple components, these components cannot be contained in different component slots of another arrow symbol, because these components are located at a single (or undistinguishable) position to which the arrow symbol points. Similarly, if the tail slot of an arrow symbol contains multiple components, these components cannot be contained in different component slots of another arrow symbol
- The head of an arrow symbol cannot simultaneously have a direct link and an indirect link with two different parts of another arrow symbol, because the head is a single point. Similarly, the tail of an arrow symbol cannot simultaneously have a direct link and an indirect link with two different parts of another arrow symbol.

These three conditions on the topological relations yield the following constraints on the 9-link matrix, respectively:

- The first column, third column, first row, and third row may have at most one direct (*D*) or mixed (*D & I*) link.
- The first column, third column, first row, and third row may have at most one indirect (*I*) or mixed (*D & I*) link.
- The first column, third column, first row, and third row may not have both indirect (*I*) and direct (*D*) link at the same time.

These three constraints compile the following single constraint:

- The first column, third column, first row, and third row have at most one non-empty element.

Among the 262,144 patterns of the 9-link matrix, only 1,864 patterns satisfy this constraint (Table 3.1). This indicates that the 9-link matrix distinguishes 1,864 topological relations between two arrow symbols. Among the 1,864 topological relations, 184 relations are symmetric, while the rest form 840 pairs of converse relations.

Table 3.1: Number of patterns of the 9-link matrices satisfying the constraint.

		Number of non-empty cells except $m_{L,22}$					
		0	1	2	3	4	
$m_{L,22}$	empty	1	$8 \times 3^1$	$16 \times 3^2$	$8 \times 3^3$	$1 \times 3^4$	466
	non-empty	$1 \times 3^1$	$8 \times 3^2$	$16 \times 3^3$	$8 \times 3^4$	$1 \times 3^5$	1,374
		4	96	576	864	324	1,864

### 3.3.3. Analysis of Topological Relations Established by Direct Links

If the entries of the 9-link matrix are limited to  $\emptyset$  and  $D$ , the 9-link matrix has  $2^9 = 512$  patterns, among which 68 patterns satisfy the previous constraint. This indicates that for two arrow symbols the 9-link matrix distinguishes 68 topological relations that are established by direct links alone (Table 3.2). These 68 topological relations between two arrow symbols exactly match with the 68 topological relations between two directed line segments embedded in  $\mathbf{R}^2$  (Kurata and Egenhofer 2006a).

Table 3.2: 68 topological relations between two arrow symbols, which have no indirect links.

	Without Direct Body-Body Link				With Direct Body-Body Link			
	Symmetric	Asymmetric		Symmetric	Asymmetric		Symmetric	Asymmetric
0	#1 				#35 			
1	#2 	#4 	#6 	#8 	#36 	#38 	#40 	#42 
	#3 	#5 	#7 	#9 	#37 	#39 	#41 	#43 
2	#10 	#14 	#18 	#22 	#44 	#48 	#52 	#56 
	#11 	#15 	#19 	#23 	#45 	#49 	#53 	#57 
3	#12 	#16 	#20 	#24 	#46 	#50 	#54 	#58 
	#13 	#17 	#21 	#25 	#47 	#51 	#55 	#59 
4	#26 	#28 	#30 	#32 	#60 	#62 	#64 	#66 
	#27 	#29 	#31 	#33 	#61 	#63 	#65 	#67 
4	#34 				#68 			

These 68 relations are schematized by a conceptual neighborhood graph (Egenhofer and Al-Taha 1992; Freksa 1992). In the conceptual neighborhood graph, each node corresponds to a relation, and each link indicates that two relations corresponding to the linked two nodes are *conceptual neighbors* (Freksa 1992), which are topologically similar relations between which a continuous transformation can be performed without having to go through a third relation. For example, the relations #2 and #18 are conceptual neighbors, because #18 is derived from #2 by moving the head of one arrow symbol from another's exterior to its body. The conceptual neighborhood graph of the 68 relations is derived computationally by linking all pairs of relations with a single difference across their 9-link matrices. Such pairs are always conceptual neighbors, equivalent to type-A neighbors for 1-dimensional intervals (Freksa 1992), because a change of one entry in the 9-link matrix reflects an atomic change, dissolving either an intersection of two boundary elements, or an intersection between a boundary element and a body, or an intersection between two bodies.

Figure 3.11 shows the conceptual neighborhood graph of the relations #1 through #34, which is homeomorphic to the conceptual neighborhood graph of the relations #35 through #68. It displays more than 34 nodes to highlight some of the regularities of the neighborhoods by repeating the nodes in the front and back row as well as in the left and right column. The graph reveals the special status of the relations #10 and #11 as the only relations with two conceptual neighbors among their 34 companions without body-body intersections.

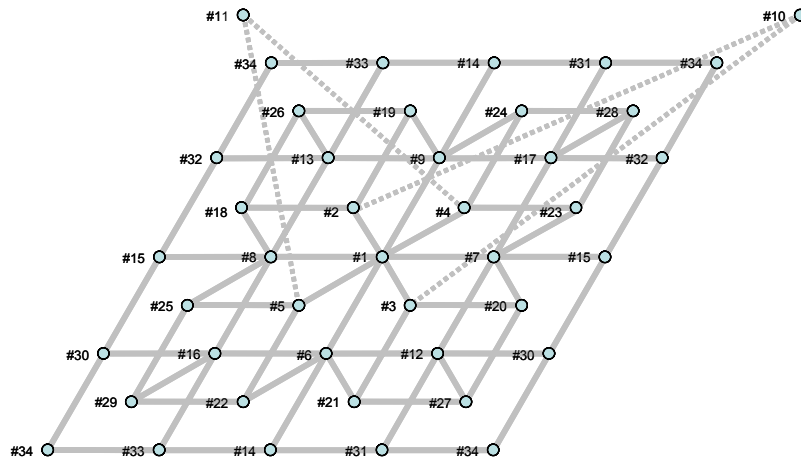

Figure 3.11: The conceptual neighborhood graph of the relations #1 through #34, illustrated on a plane.

The conceptual neighborhood graphs in Figure 3.11 have the following unique characteristics:

- Relations with fewer direct links are located closer to the center.
- Relations located on the diagonal from top-left to bottom-right are symmetric (Figure 3.12a).
- Pairs of relations that are located symmetrically across the diagonal from top-left to bottom-right are converse, that is, the same matrices are obtained by transposing the matrices along their main diagonals (Figure 3.12a).
- The conceptual neighborhood graph can be decomposed into four subgraphs with a horizontal and vertical mirror axis such that the same matrices are obtained by reversing the direction of one arrow symbol (Figure 3.12b).



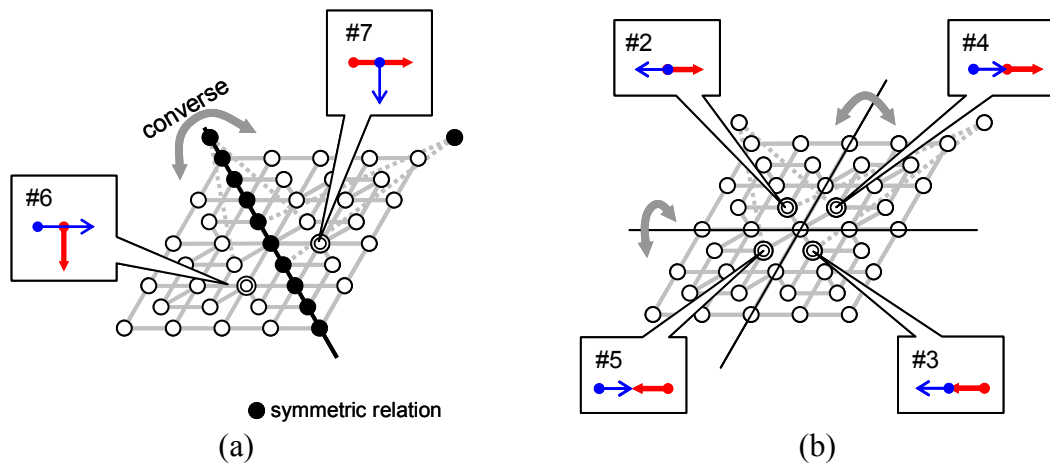

Figure 3.12: Characteristics of the conceptual neighborhood graph in Figure 3.11: (a) symmetric and converse relations and (b) the four subgraphs that are obtained by reversing the direction of an arrow symbol when mirroring the relation along the graph's horizontal or vertical axis.

Gluing the front and back rows of the conceptual neighborhood graph in Figure 3.11, and then the leftmost and rightmost columns, yields a non-redundant configuration, in which the graph extends over the surface of a torus Figure 3.13b. Relations #10 and #11, which are placed irregularly above the flat graph in Figure 3.11, are now outside the torus (Figure 3.13b).

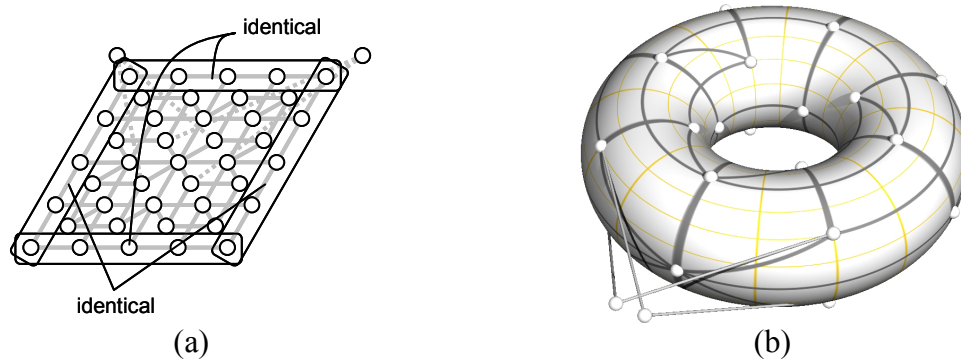

Figure 3.13: The transition from (a) the flat conceptual neighborhood graph of the relations #1 through #34 with repeated columns and rows to (b) a graph displayed on the surface of a torus, which is obtained by gluing together the repeated rows and columns along the fringes of the flat graph

The integrated conceptual neighborhood graph of the relations #1 through #68 has a two-layered structure, where each layer contains a homeomorphic conceptual neighborhood graph of #1 through #34 or #35 through #68, and each node in one layer is linked uniquely to one node in another layer, thereby representing the neighbor relation between # $n$  and # $(n+34)$  with  $1 \leq n \leq 34$ . Consequently, the conceptual neighborhood graph of the relations #1 through #68 can be represented in a 3-dimensional space where nodes are aligned on two parallel planes (Figure 3.14a) or on the surfaces of two nested tori (Figure 3.14b), with links across the two planes or surfaces to represent the neighbor relations between # $n$  and # $(n+34)$ .

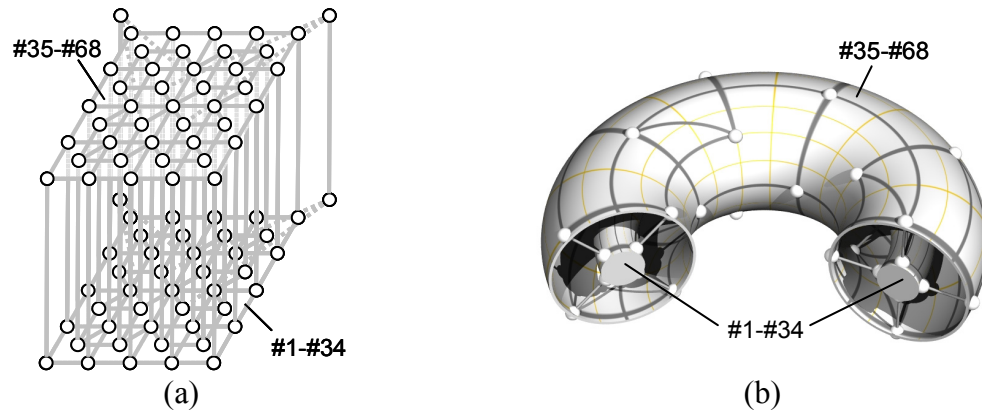

Figure 3.14: Two structures of the conceptual neighborhood graph of the relations #1 through #68, where nodes are aligned on (a) two parallel planes and (b) the surfaces of two nested tori.

### 3.4. Demonstration

This chapter has introduced two types of structures in arrow diagram, which capture the configuration of arrow diagrams from two different perspectives. To demonstrate how these two types of structures work complementarily, this section considers the structures

of two examples in Figure 3.15. These two examples are revisited in Section 5.4.3, where we demonstrate the process of deriving the interpretation of arrow symbols making use ofn the patterns of the two structures.

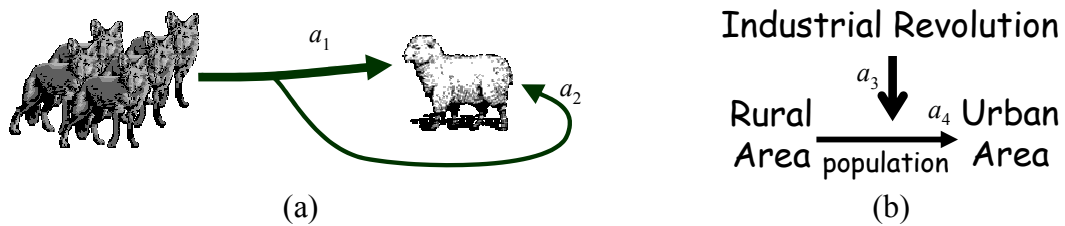

Figure 3.15: Two 2-arrow diagrams that capture that (a) a pack of wolves splits into two packs, which approach a sheep from front and behind, and that (b) the industrial revolution leads to the population drift from rural area to urban area.

### 3.4.1. Example 1: Wolves' Attack Scenario

Figure 3.16 is a flowchart of the process of deriving the individual structures and the inter-arrow structure of the multi-arrow diagram in Figure 3.15a.

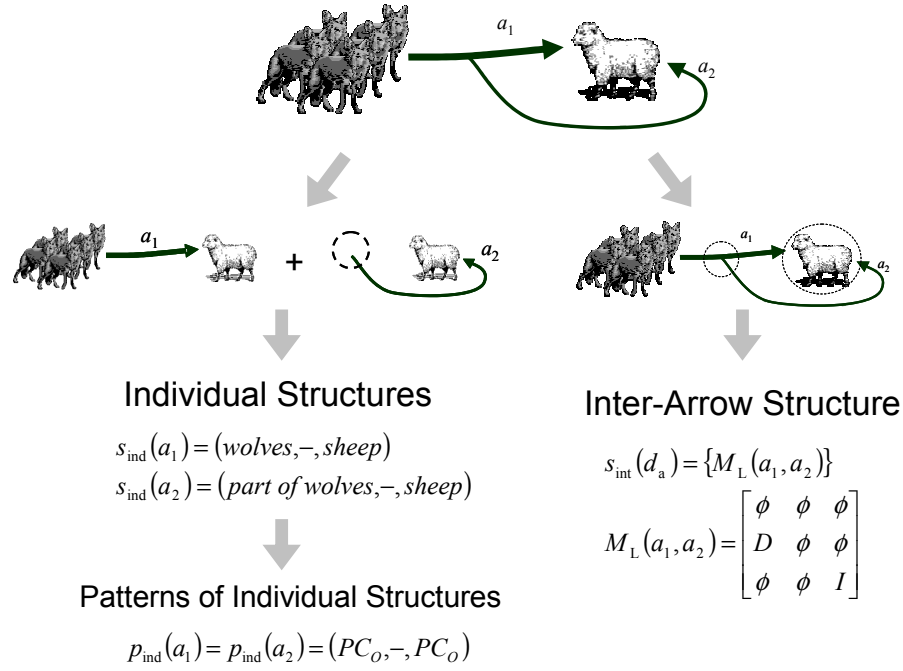

Figure 3.16: The process of deriving the individual structures and the inter-arrow structure of the multi-arrow diagram in Figure 3.15a.

Figure 3.15a has two arrow symbols  $a_1$  and  $a_2$ , which are associated with the individual structures in Equation 8. The  $a_2$ 's tail component is a part of the wolves, although it is not explicitly illustrated in the diagram.

$$\begin{aligned} s_{\text{ind}}(a_1) &= (\text{wolves}, -, \text{sheep}) \\ s_{\text{ind}}(a_2) &= (\text{part of wolves}, -, \text{sheep}) \end{aligned} \quad (8)$$

These two individual structures have the same patterns (Equation 9)

$$p_{\text{ind}}(a_1) = p_{\text{ind}}(a_2) = (PC_o, -, PC_o) \quad (9)$$

Since Figure 3.15a has only one pair of arrow symbols, the inter-arrow structure consists of a single 9-link matrix  $M_L(a_1, a_2)$ , which captures the topological

relation between  $a_1$  and  $a_2$ . This topological relation is established by a direct body-tail link and an indirect head-head link (Equation 10).

$$s_{\text{int}}(d_a) = \{M_L(a_1, a_2)\}$$

$$M_L(a_1, a_2) = \begin{bmatrix} \phi & \phi & \phi \\ D & \phi & \phi \\ \phi & \phi & I \end{bmatrix} \quad (10)$$

### 3.4.2. Example 2: Industrial Revolution Scenario

The arrow symbols  $a_3$  and  $a_4$  in Figure 3.15b are associated with the individual structures in Equation 11. The arrow diagram is nested, since  $a_3$ 's head component is an arrow diagram “*Rural Area* → *Urban Area* .”  
population

$$s_{\text{ind}}(a_3) = \left( \text{"Industrial Revolution", -, "Rural Area} \rightarrow \text{Urban Area"} \right)$$

$$s_{\text{ind}}(a_4) = \left( \text{"Rural Area", "population", "Urban Area"} \right) \quad (11)$$

These two individual structures have the patterns in Equation 12. The subordinate diagram “*Rural Area* → *Urban Area* ,”  
population which refers to a spatial movement, is considered as an ongoing event.

$$p_{\text{ind}}(a_3) = (PC_E, -, PC_E)$$

$$p_{\text{ind}}(a_4) = (PC_L, PC_O, PC_L) \quad (12)$$

The inter-arrow structure of the 2-arrow diagram in Figure 3.15b consists of a single 9-link matrix, which captures the topological relation between  $a_3$  and  $a_4$  established by their direct head-body link (Equation 13).

$$s_{\text{int}}(d_a) = \{M_L(a_3, a_4)\}$$

$$M_L(a_3, a_4) = \begin{bmatrix} \phi & \phi & \phi \\ \phi & \phi & \phi \\ \phi & D & \phi \end{bmatrix} \quad (13)$$

### 3.5. Summary

This chapter introduced two types of structures in arrow diagrams. These structures capture the configurations of arrow diagrams complementarily. The *individual structures* model the spatial arrangement of components around individual arrow symbols, while the *inter-arrow structures* model the spatial arrangement of multiple arrow symbols in arrow diagrams. The individual structure is represented as a 3-tuple, whose elements show the components in the arrow symbol's three component slots. Based on the distinction of two component categories, primary and modifier components, and further distinction of four sub-categories of primary components (location, moment, object, and event), the pattern of such an individual structure is captured as a 3-tuple which shows the type of all components in the three component slots. The inter-arrow structure is the set of topological relations between all pairs of arrow symbols in a multi-arrow diagram. The topological relation between two arrow symbols is characterized by the presence or absence of nine types of direct links and nine types of indirect links between the arrow symbols. To concisely represent such topological relation the 9-link matrix is introduced. The two structures of arrow diagrams form the foundation for the interpretation of arrow symbols.

## Chapter 4

# INTERPRETATIONS OF ARROW SYMBOLS IN 1-ARROW DIAGRAMS

This chapter develops a method for deriving the interpretation of arrow symbols in 1-arrow diagrams. We consider four classes of semantic roles—*orientation*, *behavioral description*, *annotation*, and *association*—from which the interpretation of each arrow symbol is made. A 1-arrow diagram has one individual structure and no inter-arrow structure. The configuration of the individual structure is tightly related to the semantic role of the arrow symbol, since in order to use an arrow symbol for a semantic roles the individual structure must satisfies one of the basic formats peculiar to the semantic role (Kurata and Egenhofer 2005b). This chapter, therefore, identifies for each class of semantic roles the basic formats of individual structures, as well as rules for adding optional components to the basic formats.

This chapter starts with the classification of the semantic roles of arrow symbols (Section 4.1). Section 4.2 identifies a set of basic formats, which individual structures must satisfy when arrow symbols are used for each class of semantic roles. Meanwhile, Section 4.3 identifies a set of rules for adding optional components to the individual structures. The combination of the basic formats and the optional components determines all patterns of individual structures that correspond to each class of semantic roles, which are essential for the interpretation of arrow symbols. Thus, first, with a focus on *simple 1-arrow diagrams* (i.e., arrow diagrams with at most one component in each

slot), Section 4.4 derives all patterns of individual structures that correspond to each class of semantic roles, and demonstrates that the patterns of individual structures are certainly helpful for deriving the interpretations of arrow symbols. Finally, Section 4.5 develops an algorithm for deriving all possible interpretations of arrow symbols from the patterns of given individual structures.

#### 4.1. Classification of Semantic Roles

Arrow symbols have a large variety of semantic roles (Section 2.2), which make the interpretation difficult. To simplify the discussion, the semantic roles of arrow symbols are classified into four classes (Figure 4.1).

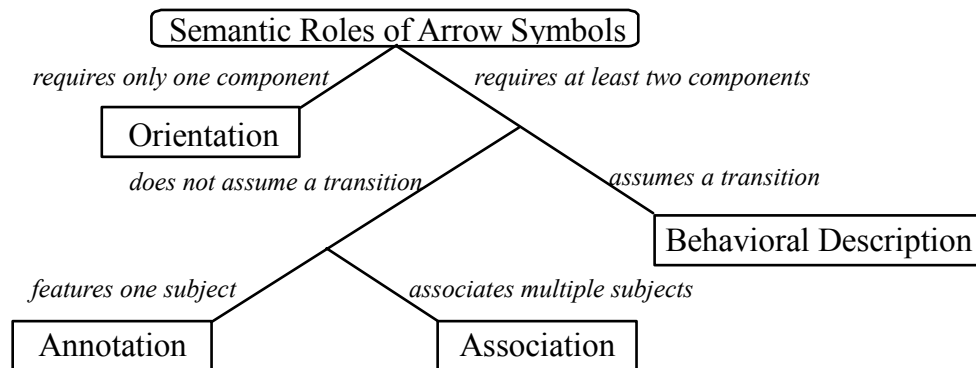

Figure 4.1: Classification of semantics roles of arrow symbols.

First, the semantic roles are dichotomized into those that require only one component and those that require at least two components. In the group with a single requisite component, the arrow symbol is attached to a component and specifies a directional property of this component (Section 2.2.1). This semantic role is called



*orientation*. Although an arrow symbol for *orientation* may refer to more than one component, only one of them is essential for assigning the semantic role to the arrow symbol, while the others are optional (Section 4.2.1).

The group with two or more requisite components is further dichotomized into *behavioral description* and others, depending on whether a transition of certain subject is projected upon the arrow symbol. Spatial movement is a spatial transition and continuous existence is a temporal transition. Therefore, illustrations of spatial movement (Section 2.2.2) and continuous existence (Section 2.2.4) are categorized into *behavioral description*. In addition, a transition may yield interactions with other components on the route (Section 2.2.3) and a transition may yield the change of the subject (Section 2.2.5). The shape of an arrow symbol is often meaningful for this category, as it may capture the route of the transition.

Arrow symbols with the remaining semantic roles connect multiple components without implying a transition. Among those semantic roles labeling (Section 2.2.6) is an exception, because the connected components refer to the same single subject, while the other semantic roles always associate different subjects. Thus, labeling is distinguished from the other semantic roles and referred to as an independent class, called *annotation*.

The remaining semantic roles are categorized into a single class, called *association*, since the arrow symbols associate different subjects. Conventionally one arrow symbol associates two subjects, due to its linearity. Such association usually indicates the presence of an asymmetric relation between these two subjects. These

relations do not include interactions, since an interaction assumes a transition of one entity approaching another and, therefore, the illustration of interaction is categorized into *behavioral description* rather than *association*.

## 4.2. Basic formats of Individual Structures

When an arrow symbol is used for a certain semantic role, its individual structure satisfies one of the formats specific to the semantic role. Among such formats, this section identifies *basic formats*, which refer to the minimum set of components that are necessary for establishing the semantic roles of arrow symbols.

### 4.2.1. Basic Formats for Orientation

An arrow symbol for *orientation* refers to a single component (subject), specifying its directional property. The arrow symbol points to, originates from, or passes through or by the subject, typically implying that the directional property is related to an outgoing action, a passing action, or an incoming action, respectively (Figure 4.2). Accordingly, *orientation* corresponds to the three basic formats in Figure 4.3.

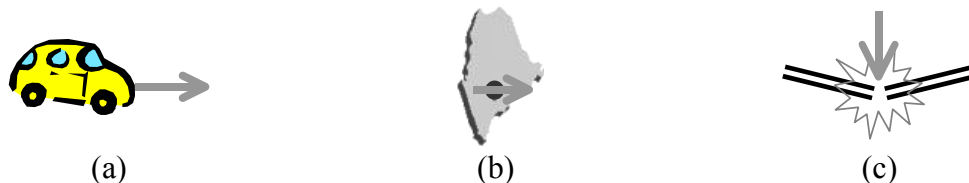

Figure 4.2: Diagrams with arrow symbols for *orientation*, specifying (a) the moving direction of a vehicle, (b) a wind direction of a point in Maine, and (c) the direction of an external force by which a board cracks.

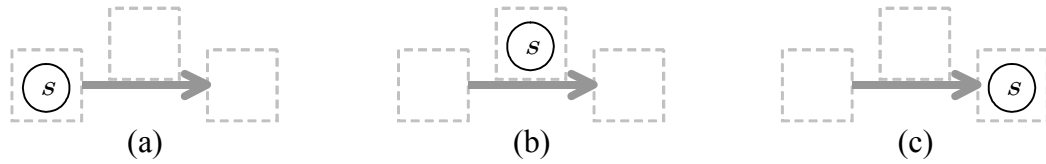

Figure 4.3: Three basic formats of individual structures that correspond to *orientation* (*s*: subject).

The subject must be a primary component, which represents an independent concept. Among the four subcategories of primary components (i.e., location, moment, object, and event), the subject cannot be a moment, since the moment, which is a zero-dimensional concept, does not have a directional property. On the other hand, the 1-arrow diagrams in Figure 4.2a-c, whose subjects are a vehicle, a point in Maine, and a cracking event, indicate that the subject may be an object, a location, and an event, respectively. Consequently, when an arrow symbol is used for *orientation*, its individual structure must satisfy one of the *prescriptive patterns* in Table 4.1; that is, there must be at least one combination of the tail, body, and head components such that their component types correspond to one of the nine prescriptive patterns in Table 4.1. For instance, the patterns  $(PC_L, -, -)$ ,  $(PC_L, MC, -)$  and  $(PC_LMC, MC, -)$  satisfy the prescriptive pattern  $(PC_L, , )$ . The blanks in prescriptive patterns mean that the corresponding component slots may be empty *or* filled by optional components (Section 4.3.2). In Table 4.1,  $(PC_{L|O|E}, , )$ , which represents  $(PC_L, , )$ ,  $(PC_O, , )$ , and  $(PC_E, , )$ , is counted as three patterns. Table 4.1, therefore, indicates that there are  $3 \times 3 = 9$  prescriptive patterns that correspond to *orientation*.

Table 4.1: Nine prescriptive patterns that individual structures must satisfy when arrow symbols are used for *orientation* ( $s$ : subject,  $PC_{L|O|E}$ :  $PC_L$ ,  $PC_O$ , or  $PC_E$ ).

Basic Format	Prescriptive Patterns
$(s, , )$	$(PC_{L O E}, , )$
$( , s, )$	$( , PC_{L O E}, )$
$( , , s)$	$( , , PC_{L O E})$

#### 4.2.2. Basic Formats for Behavioral Description

An arrow symbol for *behavioral description* illustrates the transition of a single subject<sup>3</sup>. A spatial transition refers to the subject’s movement, while a temporal transition refers to the subject’s persistence over a temporal period. The transition may refer to a set of positions in space and time. If a component representing a spatial position is located in the tail, body, and head slot, this component specifies the origin, intermediate points, and destination of the transition, respectively. Similarly, if a component representing the temporal position is located in the tail, body, and head slot, this component specifies the start time, intermediate times, and end time of the transition, respectively. The transition may also refer to entities on the route, with which the subject interacts. If such an entity is drawn in the arrow symbol’s tail, body, and head slots, the interaction takes place before, during, and after the transition, respectively.

---

<sup>3</sup> An arrow symbol may illustrate the transition of multiple entities (e.g., people in a queue in Figure 3.9d), but these entities are regarded as a single group subject, whose members have the common roles in the illustrated scenario.

When an arrow symbol is used for behavioral description, its individual structure must satisfy the following four constraints:

- The subject ( $s$ ) is located in any component slot, except when the diagram highlights the change of the subject by illustrating the subject before and after the transition in the tail and head slots, respectively.
- In addition to the subject, the arrow symbol refers at least one component representing the transition-related position or the entity involved in the transition; otherwise the arrow symbol refers to the subject alone and, accordingly, the arrow symbol specifies a directional property rather than illustrates a transition.
- Each involved entity ( $e$ ) cannot coexist at the same place with the subject; otherwise the diagram no longer implies that the interaction between the subject and  $e$  is triggering or triggered by the subject's transition. In addition, it is assumed that more than one involved entity cannot coexist at the same place<sup>4</sup>. Accordingly, each involved entity cannot be located in the tail or head slot that already contains the subject or another involved entity.
- Each transition-related position ( $p$ ) cannot coexist at the same location with the subject and the involved entities; otherwise such a component specifying a position is regarded an adjective component (Section 4.3.1), which is attached to the nearby

---

<sup>4</sup> A set of entities involved in the transition, located at the same place, are treated as a single group entity, whose members share the same role in the illustrated scenario.

component (i.e., a subject or an involved entity) and specifies its spatial or temporal position. Accordingly, each transition-related position cannot be located in the tail or head slot that already contains the subject, involved entity, or another transition-related position.

- The body slot, which has length, may contain the subject, one or more involved entities, and one or more transition-related positions at the same time.

These five constraints determine the fifteen basic formats under which an arrow symbol is used for behavioral description (Table 4.2).

Table 4.2: Fifteen basic formats of individual structures that correspond to *behavioral description* ( $s$ : subject,  $e$ : entity involved in the transition,  $p$ : position related to the transition,  $e|p$ : either  $e$  or  $p$ ,  $[e|p]^n$ : one or more  $e|p$ ).

		Basic Formats		
<i>in Head Slot</i>				
	<i>in Tail Slot</i>			
<i>Single Subject</i>				
	<i>in Body Slot</i>			
<i>Two Subjects</i>				

The subject  $s$  must be either an object or an event, considering that objects and events may actively change their spatial and temporal positions, but locations and moments do not. Each involved entity  $e$  must be an object, an event, or a location, considering that it is possible to interact with objects, events, and locations, but not with moments. Each transition-related position is obviously a location or a moment. As a consequence, when an arrow symbol is used for *behavioral description*, its individual structure must satisfy one of the prescriptive patterns in Table 4.3.

Table 4.3: 104 prescriptive patterns that individual structures must satisfy when arrow symbols are used for *behavioral description* ( $s$ : subject,  $e$ : entity involved in the transition,  $p$ : position related to the transition).

	Format	Prescriptive Patterns	
Single Subject	in Head Slot	$(s, [e p]^n, e p)$	$(PC_{O E}, [PC_{L M O E}]^n, PC_{L M O E})$
		$(s, [e p]^n, )$	$(PC_{O E}, [PC_{L M O E}]^n, )$
		$(s, , e p)$	$(PC_{O E}, , PC_{L M O E})$
	in Tail Slot	$(e p, [e p]^n, s)$	$(PC_{L M O E} [PC_{L M O E}]^n, PC_{O E})$
		$( , [e p]^n, s)$	$( , [PC_{L M O E}]^n, PC_{O E})$
		$(e p, , s)$	$(PC_{L M O E}, , PC_{O E})$
	in Body Slot	$(e p, s[e p]^n, e p)$	$(PC_{L M O E}, PC_{O E}[PC_{L M O E}]^n, PC_{L M O E})$
		$( , s[e p]^n, )$	$( , PC_{O E}[PC_{L M O E}]^n, )$
		$(e p, s, e p)$	$(PC_{L M O E}, PC_{O E}, PC_{L M O E})$
		$(e p, s[e p]^n, )$	$(PC_{L M O E}, PC_{O E}[PC_{L M O E}]^n, )$
$(e p, s, )$		$(PC_{L M O E}, PC_{O E}, )$	
$( , s[e p]^n, e p)$		$( , PC_{O E}[PC_{L M O E}]^n, PC_{L M O E})$	
$( , s, e p)$		$( , PC_{O E}, PC_{L M O E})$	
Two Subjects	$(s, [e p]^n, s)$	$(PC_{O E}, [PC_{L M O E}]^n, PC_{O E})$	
	$(s, , s)$	$(PC_{O E}, , PC_{O E})$	

### 4.2.3. Basic Formats for Annotation

An arrow symbol for *annotation* attaches a label to a subject, thereby specifying such a property of the subject as name, type, status, spatial position, and temporal position (Figure 4.4). Conventionally, *annotation* corresponds to only one format of individual structures in Figure 4.5, where an arrow symbol originates from the label and points to the subject, implying an asymmetric relation that the label is assigned to the subject.

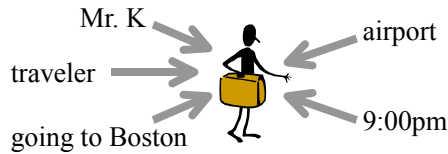

Figure 4.4: An arrow diagram with five arrow symbols, all used for *annotation*.

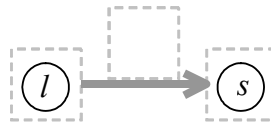

Figure 4.5: Only one basic format of the individual structures that correspond to *annotation* (*l*: label, *s*: subject).

The label must be a modifying component, since it modifies the subject, while the subject must be a primary component. Consequently, when an arrow symbol is used for *annotation*, its individual structure must satisfy one of the four prescriptive patterns in Table 4.4.

Table 4.4: Four prescriptive patterns that individual structures must satisfy when arrow symbols are used for *annotation* (*l*: label, *s*: subject).

Basic Format	Prescriptive Patterns
$(l, s)$	$(MC, PC_{L MO E})$



#### 4.2.4. Basic Formats for Association

An arrow symbol for *association* associates two different subjects, indicating the presence of an asymmetric relation between them. These subjects are placed in the tail slot and the head slot of the arrow symbols (Figure 4.6), such that these two subjects look equally emphasized while their order is highlighted.



Figure 4.6: Only one basic format of the individual structures that correspond to *association* ( $s_1, s_2$ : associated subjects)

The asymmetric relation that holds between the two subjects is called the *effective relation*. For instance, in the arrow diagram “*El Niño*  $\rightarrow$  *Fish Catch* $\downarrow$ ,” a typical effective relation between “*El Niño*” and “*Fish Catch* $\downarrow$ ” is *causality*. Such effective relation may be specified by an adverbial component in the body slot (Section 4.3.2), or described in the caption or the legend; otherwise, the diagram reader has to infer an appropriate effective relation from the context or the reader’s knowledge about the plausible relations between the subjects. The effective relation may provide an ordering rationale, which naturally determines the order of the associated subjects; otherwise, the order is arbitrarily determined (Table 4.5).

Table 4.5: Associated subjects and effective relations between them, which may naturally determine the order of the associated subjects.

Associated Subjects	Effective Relation	Ordering Rationale	Representation
El Niño, Fish Catch ↓	Causality	logical order	El Niño→Fish Catch↓
Plan, Do, See	work process	temporal order	Plan→Do→See
Niagara Falls, Lake Ontario	water flow	spatial order (high to low)	Niagara Falls→Lake Ontario
Maine, New England	geographical attribution	spatial order (part to whole)	Maine→New England
Lobster, Maine	local product	-	Lobster→Maine Maine→Lobster

Each subject must be a primary component, since it represents an independent concept. Any subcategory of a primary component (i.e., *a location, a moment, an object* or *an event*) can be the subject, as long as an appropriate effective relation can be found between the pair of subjects. Accordingly, when an arrow symbol is used for *association*, its individual structure must satisfy one of the  $4 \times 4 = 16$  prescriptive patterns in Table 4.6.

Table 4.6: Sixteen prescriptive patterns that individual structures must satisfy when arrow symbols are used for *association* ( $s_1, s_2$ : associated subjects).

Basic Format	Prescriptive Pattern
$(s_1, s_2)$	$(PC_{L M O E}, PC_{L M O E})$

### 4.3. Rules for Optional Components

Individual structures may have optional components, which enrich the diagram’s semantics, but are not requested by the previous basic formats. This section distinguishes two types of such optional components—*adjective components* and *adverbial components*—and identifies a set of rules for adding such optional components to the individual structures.

#### 4.3.1. Adjective Components

*Adjective components* correspond to *adjectives* in natural language. Like an adjective that modifies a single noun, an adjective component modifies a component nearby, and specifies a property of this component such as name, spatial position, and temporal position (Figure 4.7). Naturally, each adjective component is a modifier component, which coexists with the modified component in the same component slot.

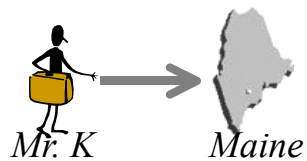

Figure 4.7: A 1-arrow diagram with two adjective components, “*Mr. K*” and “*Maine*,” each of which specifies the name of an entity illustrated nearby.





### 4.3.2. Adverbial Components

*Adverbial components* correspond to *adverbial phrases* in natural language. Similar to an adverbial phrase that modifies a verb, an adverbial component modifies the semantic role of an arrow symbol. Four different scenarios arise:

- When an arrow symbol is used for *orientation*, the adverbial components provide information about the directional property specified by the arrow symbol, such as type, name, and scale (Table 4.7a<sub>1</sub>-a<sub>3</sub>).
- When an arrow symbol is used for *behavioral description*, the adverbial components provide information about the illustrated transition, such as type of the transition and accompanying interactions, scale, cause of the transition, overall spatial or temporal position where and when the transition and accompanying interactions take place (Table 4.7b<sub>1</sub>-b<sub>4</sub>).
- When an arrow symbols is used for *annotation*, the arrow symbol does not refer to adverbial components, because they are simply unnecessary.
- When an arrow symbol is used for *association*, the adverbial components provide information about the illustrated relation, such as effective relation (Section 4.2.4) and overall spatial or temporal position where and when the relation is effective (Table 4.7c<sub>1</sub>-c<sub>3</sub>).

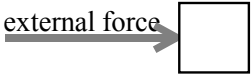
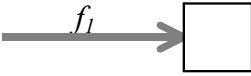
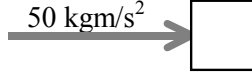
Adverbial components are placed in the body slot, normally in its center, implying that the adverbial component is assigned to the entire arrow symbol. Naturally, each adverbial component is a modifier component.

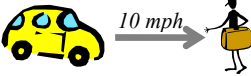
Table 4.7: Information provided by adverbial components.

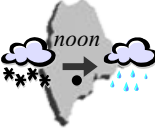
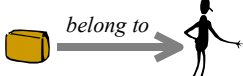
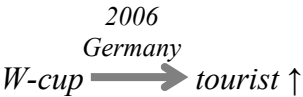
Semantic Role	Provided Information			
<i>orientation</i>	 (a <sub>1</sub> ) property type	 (a <sub>2</sub> ) property name	 (a <sub>3</sub> ) property scale	
<i>behavioral description</i>	 (b <sub>1</sub> ) type of the transition and accompanying interactions	 (b <sub>2</sub> ) transition scale	 (b <sub>3</sub> ) cause of transition	 (b <sub>4</sub> ) overall spatial / temporal position where and when the transition and accompanying interactions take place
<i>association</i>	 (c <sub>1</sub> ) effective relation	 (c <sub>2</sub> ) overall spatial / temporal position where and when the relation is effective		

#### 4.4. Interpretations of Arrow Symbols in Simple 1-Arrow Diagrams

The combination of the prescriptive patterns of individual structures (Section 4.2) and the optional components (Section 4.3) determines the patterns of the individual structures that correspond to each class of semantic roles. However, the number of such patterns is theoretically countless, since the individual structures may have an arbitrary number of optional components. To focus the discussion, this section considers only *simple 1-arrow diagrams*, which contain at most one component in each component slot. The individual

structure of a simple arrow diagram, called the *simple individual structure*, distinguishes  $6^3 = 216$  patterns, since each of the three component slots may contain one out of six choices: an object, an event, a location, a moment, a modifier component, or nothing. Consequently, for each class of semantic roles, all corresponding patterns of simple individual structures can be determined from the 216 patterns.

#### 4.4.1. Patterns of Simple 1-Arrow Diagrams for Orientation

When an arrow symbol is used for *orientation*, its simple individual structure satisfies one of the three basic formats in Figure 4.3 and may have an adverbial component in the body slot if empty (Section 4.3.2). Thus, *orientation* corresponds to five formats in Table 4.8. In each format, the subject must be a location, an object, or an event (Section 4.2.1), while the adverbial component, if it exists, is a modifier component (Section 4.3.2). Consequently,  $5 \times 3 = 15$  patterns of simple individual structures in Table 4.8 correspond to *orientation*.

Table 4.8: Five formats and fifteen patterns of simple individual structures that correspond to *orientation* (*s*: subject, *c<sub>av</sub>*: adverbial component)

Format	Patterns
$(s, -, -)$	$(PC_{L O E}, -, -)$
$(s, c_{av}, -)$	$(PC_{L O E}, MC, -)$
$(-, s, -)$	$(-, PC_{L O E}, -)$
$(-, -, s)$	$(-, -, PC_{L O E})$
$(-, c_{av}, s)$	$(-, MC, PC_{L O E})$

#### **4.4.2. Patterns of Simple 1-Arrow Diagrams for Behavioral Description**

When an arrow symbol is used for *behavioral description*, its individual structure satisfies one of the fifteen basic formats in Table 4.2 and may have one adverbial component in the body slot if empty (Section 4.3.2). Thus, *behavioral description* corresponds to 18 formats in Table 4.9. In each format, the subject must be an object or an event, each entity involved in the transition must be an object, an event, or a location, and each position related to the transition must be a location or a moment (Section 4.2.2), while the adverbial component, if it exists, is a modifier component. (Section 4.3.2). Consequently, 104 patterns of simple individual structures in Table 4.8 correspond to *behavioral description*.

Table 4.9: Eighteen formats and 104 patterns of simple individual structures that correspond to *behavioral description* ( $s$ : subject,  $e$ : entity involved in the transition,  $p$ : position related to the transition). The patterns may overlap between the rows.

	Format	Patterns
in Head Slot	$(s, [e p]^n, e p)$	$(PC_{O E}, PC_{L M O E}, PC_{L M O E})$
	$(s, [e p]^n, -)$	$(PC_{O E}, PC_{L M O E}, -)$
	$(s, -, e p)$	$(PC_{O E}, -, PC_{L M O E})$
	$(s, c_{av}, e p)$	$(PC_{O E}, MC, PC_{L M O E})$
in Tail Slot	$(e p, [e p]^n, s)$	$(PC_{L M O E}, PC_{L M O E}, PC_{O E})$
	$(-, [e p]^n, s)$	$(-, PC_{L M O E}, PC_{O E})$
	$(e p, -, s)$	$(PC_{L M O E}, -, PC_{O E})$
	$(e p, c_{av}, s)$	$(PC_{L M O E}, MC, PC_{O E})$
in Body Slot	$(e p, s[e p]^n, e p)$	-
	$(-, s[e p]^n, -)$	-
	$(e p, s, e p)$	$(PC_{L M O E}, PC_{O E}, PC_{L M O E})$
	$(e p, s[e p]^n, -)$	-
	$(e p, s, -)$	$(PC_{L M O E}, PC_{O E}, -)$
	$(-, s[e p]^n, e p)$	-
	$(-, s, e p)$	$(-, PC_{O E}, PC_{L M O E})$
Two Subjects	$(s, [e p]^n, s)$	$(PC_{O E}, PC_{L M O E}, PC_{O E})$
	$(s, -, s)$	$(PC_{O E}, -, PC_{O E})$
	$(s, c_{av}, s)$	$(PC_{O E}, MC, PC_{O E})$

#### 4.4.3. Patterns of Simple 1-Arrow Diagrams for Annotation

When an arrow symbol is used for *annotation*, its individual structure satisfies the format in Figure 4.5 and may have no adverbial component (Section 4.3.2). In this format, the label must be a modifier component, while the subject is any category of primary



component (Section 4.2.3). Consequently, four patterns of simple individual structures in Table 4.10 correspond to *annotation*.

Table 4.10: One format and four patterns of simple individual structures that correspond to *annotation* (*l*: label, *s*: subject).

Format	Patterns
$(l, -, s)$	$(MC, -, PC_{L M O E})$

#### 4.4.4. Patterns of Simple 1-Arrow Diagrams for Association

When an arrow symbol is used for *association*, its individual structure satisfies one of the sixteen formats in Figure 4.6 and may have an adverbial component in the body slot, if empty (Section 4.3.2). Thus, two formats correspond to *association*. In each format, the associated subjects are any type of primary components (Section 4.2.4), while the adverbial component, if it exists, is a modifier component (Section 4.3.2). Consequently,  $16 \times 2 = 32$  patterns of simple individual structures correspond to *association*.

Table 4.11: Two formats and 32 patterns of simple individual structures that correspond to *association* ( $s_1, s_2$ : associated subjects,  $c_{av}$ : adverbial component).

Format	Patterns
$(s_1, , s_2)$	$(PC_{L M O E}, -, PC_{L M O E})$
$(s_1, c_{av}, s_2)$	$(PC_{L M O E}, MC, PC_{L M O E})$

#### 4.4.5. Comparison of Patterns

Sections 4.4.1-4.4.4 identified all patterns of simple individual structure that correspond to the four classes of semantic roles. Figure 4.8 summarizes the number of patterns that correspond to each class of semantic roles. Among the 216 patterns of simple individual structures,  $15 + 4 + 8 + 80 = 107$  patterns correspond to exactly one class, 24 patterns correspond to two classes, and the remaining 85 patterns correspond to no class.

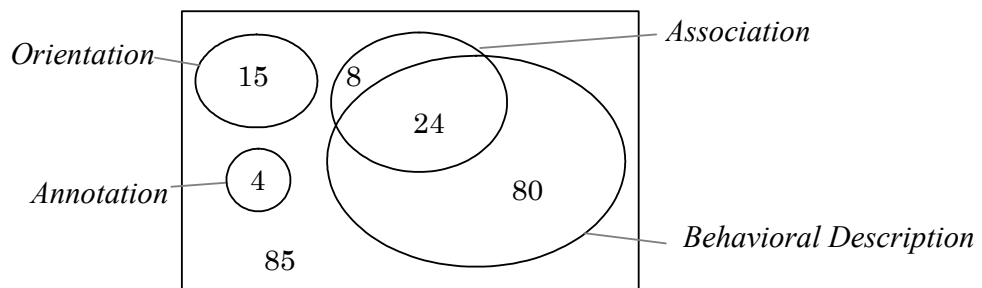

Figure 4.8: The number of patterns of simple individual structures that correspond to each class of semantic roles.

This result indicates:

- An arrow symbol, whose individual structure has one of the 107 patterns, is uniquely interpreted within the four classes of semantic roles (Figure 4.9a).
- An arrow symbol, whose individual structure has one of the 24 patterns, yields multiple interpretations: *behavioral description* and *annotation* (Figure 4.9b)
- An arrow symbol has no interpretation within the four classes of semantic roles if its individual structure has one of the remaining 83 patterns (Figure 4.9).

Figure 4.8 also indicates that arrow symbols for *orientation* and *annotation* are always uniquely interpreted, while arrow symbols for *behavioral description* and *association* may be ambiguous.

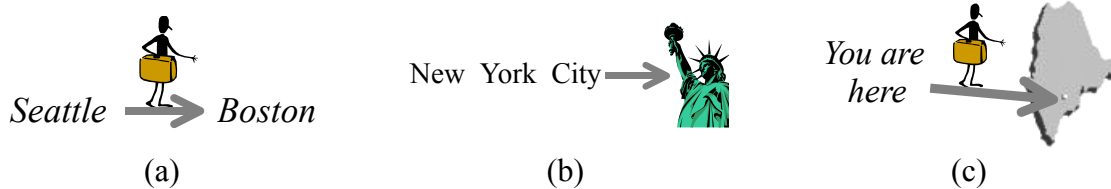

Figure 4.9: Simple 1-arrow diagrams whose individual structures have the patterns (a)  $(PC_L, PC_O, PC_L)$ , (b)  $(MC, -, PC_O)$ , (c)  $(MC, PC_O, PC_L)$ , which corresponds to one, two, and no classes of semantic roles, respectively.

#### 4.5. Interpretation of Arrow Symbols in General 1-Arrow Diagrams

This section develops an algorithm that deduces all classes of semantic roles that correspond to the given individual structure. This algorithm enables computers to derive the possible interpretations of an arrow symbol if its structural information is available. The target is expanded to general individual structures, which may have more than one component in each component slot.

The individual structure of an arrow symbol  $a$ ,  $s_{\text{ind}}(a)$ , corresponds to a semantic role  $\sigma_i$  if and only if  $s_{\text{ind}}(a)$  satisfies one of  $\sigma_i$ 's prescriptive patterns (Tables 4.1, 4.3, 4.4, and 4.6) and every extra component in  $s_{\text{ind}}(a)$  is considered as either an adverbial component or an adjective component. The individual structure  $s_{\text{ind}}(a)$  was denoted by a 3-tuple  $(C_{\text{tail}}(a), C_{\text{body}}(a), C_{\text{head}}(a))$ , where  $C_{\text{tail}}(a)$ ,  $C_{\text{body}}(a)$ , and  $C_{\text{head}}(a)$  be the respective sets of all components in  $a$ 's tail, body, and head slot

(Section 3.2). Let  $\sigma_1$ - $\sigma_4$  are the four classes of semantic roles (*orientation, behavioral description, annotation, and association*), respectively, and  $(\overline{C_{tail\ ij}}, \overline{C_{body\ ij}}, \overline{C_{head\ ij}})$  is the  $j$ th prescriptive pattern that correspond to the class  $\sigma_i$  (Tables 4.1, 4.3, 4.4, and 4.6). The number of elements in  $\overline{C_{tail\ ij}}$  and  $\overline{C_{head\ ij}}$  are one or zero, while that of  $\overline{C_{body\ ij}}$  may be two or more. Let the function  $type(c)$  give the type of a component  $c$ . With this setting, all classes of semantic roles that correspond to  $s_{ind}(a)$  are deduced computationally by the following algorithm:

```

1: results  $\leftarrow$  {}
2:  $(T, B, H) \leftarrow (\{type(c) \mid c \in C_{tail}(a)\}, \{type(c) \mid c \in C_{body}(a)\}, \{type(c) \mid c \in C_{head}(a)\})$ 
3: For every semantic class  $\sigma_i$ 
4:   For  $\sigma_i$ 's every template  $(\overline{C_{tail\ ij}}, \overline{C_{body\ ij}}, \overline{C_{head\ ij}})$ 
5:     If  $(\overline{C_{tail\ ij}} \in T) \wedge (\overline{C_{body\ ij}} \in B) \wedge (\overline{C_{head\ ij}} \in H)$  then
6:        $(T^+, B^+, H^+) \leftarrow (T \setminus \overline{C_{tail\ ij}}, B \setminus \overline{C_{body\ ij}}, H \setminus \overline{C_{head\ ij}})$ 
7:        $(T^*, B^*, H^*) \leftarrow (T^+, B^+, H^+)$ 
8:       IF  $\sigma_i <>$  "ANNOTATION" then remove all  $M$  from  $B^*$ 
9:        $S = T^* \cup B^* \cup H^*$ 
10:      If  $\neg[\{P_L \in S\} \vee \{P_M \in S\} \vee \{P_O \in S\} \vee \{P_E \in S\}]$  and  $\_$ 
           $\left[ \begin{array}{l} \{(M \in T^*) \wedge (\overline{C_{tail\ ij}} = \phi)\} \vee \{(M \in B^*) \wedge (\overline{C_{body\ ij}} = \phi)\} \\ \vee \{(M \in H^*) \wedge (\overline{C_{head\ ij}} = \phi)\} \end{array} \right]^\vee$  then  $\_$ 
          add  $\sigma_i$  to results
          End If
11:     Next
12: Next

```

$(T, B, H)$  is  $s_{\text{ind}}(a)$ 's pattern (line 2).  $(T^+, B^+, H^+)$  is the component type of all extra components in  $s_{\text{ind}}(a)$  (line 6), each of which must be either an adverbial or adjective component if the prescriptive pattern currently under inspection is valid.  $(T^*, B^*, H^*)$  is the type of the components that must be adjective components (lines 7-8). Since the adjective components must be modifier components ( $MC$ ),  $T^*$ ,  $B^*$ , and  $H^*$  cannot be  $PC_L$ ,  $PC_M$ ,  $PC_O$ ,  $PC_E$  (line 10). In addition, if  $T^*$ ,  $B^*$ , and  $H^*$  contain  $MC$ , there must be at least one element in  $\overline{C_{\text{tail } ij}}$ ,  $\overline{C_{\text{body } ij}}$ , and  $\overline{C_{\text{head } ij}}$ , respectively, since any adjective component needs an entity to be attached with (line 10).

#### 4.6. Summary

This chapter developed an algorithm for deriving the interpretations of the arrow symbol in 1-arrow diagrams. The semantic roles of arrow symbols are classified into four classes: *orientation*, *behavioral description*, *annotation*, and *association*. For each class of semantic roles, a set of prescriptive patterns of individual structures, as well as rules for adding optional components are identified. The combination of these prescriptive patterns and optional components determine all patterns of individual structures that correspond to each class of semantic roles. Accordingly, it becomes possible to deduce all classes of semantic roles that may correspond to a given individual structure, which is essentially to derive the interpretation of arrow symbols from the four choices. This chapter developed

an algorithm for such deduction of interpretations. The validity of this algorithm is evaluated in Chapter 6.

## Chapter 5

# INTERPRETATIONS OF ARROW SYMBOLS IN MULTI-ARROW DIAGRAMS

A remarkable property of multi-arrow diagrams is that arrow symbols are spatially arranged in a meaningful way. Due to this property, a multi-arrow diagram captures richer semantics than a set of 1-arrow diagrams whose synthesis forms the same multi-arrow diagram (Figure 5.1). This chapter, therefore, studies the meanings of spatial arrangements of arrow symbols and then exploits such meanings for the interpretation of arrow symbols in multi-arrow diagrams.

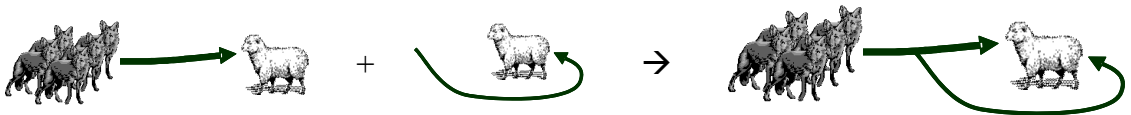

Figure 5.1: Synthesis of two 1-arrow diagrams yields a multi-arrow diagram, which captures additional semantics: the pack of wolves splits into two packs.

According to the previous observations, arrow symbols form a meaningful arrangement when they jointly capture certain semantics (Section 1.1) or when arrow diagrams are nested (Section 3.4.2). Thus, after introducing basic terminology (Section 5.1), this chapter explores several cases where arrow symbols jointly capture semantics, essentially studying the semantic roles assigned to groups of arrow symbols (Section 5.2). Then, Section 5.3 discusses the meanings and structural characteristics of nested arrow diagrams. Based on the correspondence between the spatial arrangement and the semantics found in Sections 5.2 and 5.3, Section 5.4 develops a sequential method for

deducing semantic roles of both individual arrow symbols and arrow symbol groups in a multi-arrow diagram. Finally, Section 5.5 demonstrates with two examples how this method works.

## 5.1. Terminology

The semantic roles of arrow symbols are assigned not only to individual arrow symbols, but also to groups of arrow symbols. The semantic role assigned to an individual arrow symbol is called the *individual role*, while the semantic role assigned to a group of arrow symbols is called the *group roles*.

In a multi-arrow diagram, each arrow symbol may individually capture certain semantics together with its components, just like the arrow symbol in a 1-arrow diagram does. The semantics captured by an arrow symbol  $a$  and the components referred by  $a$  is called  $a$ 's *individual semantics*. The individual semantics of an arrow symbol  $a$  is tightly related to  $a$ 's individual role, since the individual role determines the type of the individual semantics. For instance, if  $a$ 's individual role is *association*, then  $a$  and its components capture a certain relation between two of these components.

Similarly, if an arrow symbol group  $A$  has a group role, the arrow symbols in  $A$  and their components capture certain semantics, which is called  $A$ 's *group semantics*.



## 5.2. Group Roles of Arrow Symbols

This section introduces several kinds of semantic roles that are assigned to groups of arrow symbols. Each group role corresponds to specific spatial arrangements of arrow symbols, which are later exploited for the interpretation of arrow symbols (Section 5.4).

### 5.2.1. Indicating Element-Sharing

When multiple arrow symbols refer to the same component  $c$ , the individual semantics associated with these arrow symbols may be related to each other in the sense that these semantics refer to the same elements represented by  $c$ . For example, in Figure 5.2a the pair of the individual semantics—*the traveler is Mr. K* and *the traveler goes to Hawaii*—are mutually related in the sense that they refer to the same traveler. In addition, a set of individual semantics that shares an element may be *mutually-exclusive* (i.e., only one of these individual semantics can be true) or *synchronized* (i.e., whenever one is true all others are also true). For example, in Figure 5.2b the pair of the individual semantics—*an exam results in pass* and *an exam results in failure*—shares the same exam and the group members are mutually-exclusive (i.e., *an exam results in pass or fail, but not both*). On the other hand, in Figure 5.2c the pair of the individual semantics—*a cell phone sends a query to a database* and *the database returns a result to the cell phone*—are synchronized (i.e., *whenever the cell phone sends a query the database returns a result*). Background knowledge that two events typically occur simultaneously (e.g., send and return) or never occur together (e.g., pass and fail) is helpful for judging

whether the element-sharing between the individual semantics further implies their mutually-exclusiveness or synchronization. Empirically, the symmetry of the 9-link matrix (Section 3.3) is also useful, since arrow symbols are typically arranged symmetrically when illustrating the mutually-exclusive or synchronized scenarios (Figures 5.2b-c).

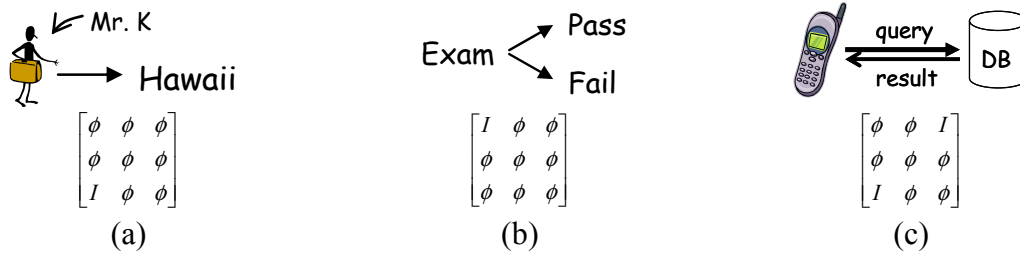

Figure 5.2: Three 2-arrow diagrams capturing pairs of element-sharing individual semantics. In addition, (b) and (c) imply that the pairs are mutually exclusive and synchronized, respectively.

### 5.2.2. Formulating a Branching Process

A *branching process* is a temporal process in which a precedent element  $p$  is followed by only one of multiple subsequent elements  $\{s_1, \dots, s_n\}$ . The branching process is conventionally represented by a multi-arrow diagram in which one arrow symbol ( $a^*$ ) directly connects  $p$  to  $s^* \in \{s_1, \dots, s_n\}$ , while the other arrow symbols connect  $a^*$ 's body to  $s_i \in \{s_1, \dots, s_n\} \setminus s^*$  (Figure 5.3a). Although only  $a^*$  originates from  $p$ , every arrow symbol conceptually refers to  $p$  as its tail component. This spatial arrangement may imply that  $p$  is normally followed by  $s^*$ , while the other subsequent elements refer to exceptional scenarios. For instance, in Figure 5.3a, the operation “*Search the address*

*book for the given name*” is normally followed by the operation “*Show the map around the found address,*” while “*Show an error message*” occurs only in an exceptional scenario.

A branching process is essentially a set of temporal orders with a common precedent element, which are mutually-exclusive. Consequently, the branching process can be also captured by a set of arrow symbols sharing a tail component (Figure 5.3b). This alternative spatial arrangement, however, cannot guarantee that the two subsequent elements are mutually exclusive.

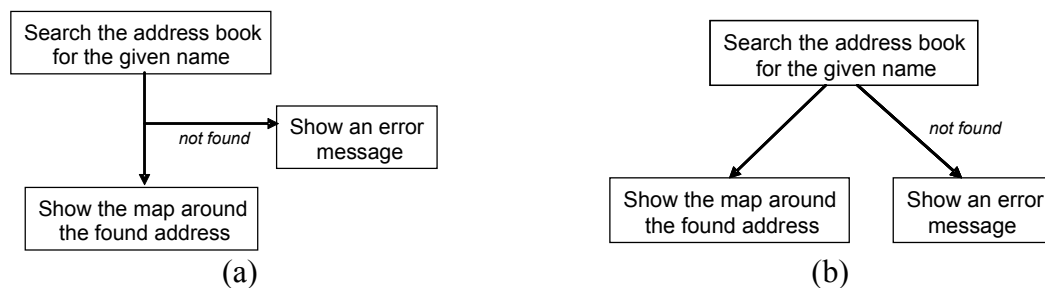

Figure 5.3: The same branching processes are captured by (a) a pair of arrow symbols with a direct body-tail link and (b) a pair of arrow symbols with an indirect tail-tail link.

### 5.2.3. Indicating Interactions during Transition

If two arrow symbols are used for *behavioral description* and they have a direct link (i.e., they intersect with each other), their intersections may indicate that the two subjects, associated with these arrow symbols, are located at the same position at the same time, having a certain interaction with each other. Since the tail, body, and head of an arrow symbol correspond to the origin, intermediate path, and destination of the subject’s

spatial transition, respectively, the nine types of direct links (Section 3.3) may naturally indicate the following interactions:

- A direct tail-tail link may indicate that the subjects get separated, possibly as a result of a precedent event (Figure 5.4a). This interaction is called *separation*.
- A direct head-head link may indicate that the subjects get together, possibly leading to a certain reaction (Figure 5.4b). This interaction is called *meeting*.
- A direct body-body link may indicate that the two subjects have a contact with each other during their transitions (Figure 5.4c). This interaction is called *contact*.
- A direct head-tail/tail-head link may indicate that the arrival of one subject leads to the departure of another subject or, if both arrow symbols refer to the same subject, the subject drops by the location at the link (Figure 5.4d). These two interactions are called *push-out* and *drop-by*, respectively.
- A direct body-tail/tail-body link may indicate that a certain event that involves a subject already in transition, such as splitting, leads to the departure of another subject (Figure 5.4e). This interaction is called *diversion*.
- A direct head-body/body-head link may indicate that one subject finishes its transition when the subject encounters another subject and possibly has a certain reaction, such as merger (Figure 5.4f). This interaction is called *confluence*.

Multiple direct links between two arrow symbols indicate a combination of these interactions.

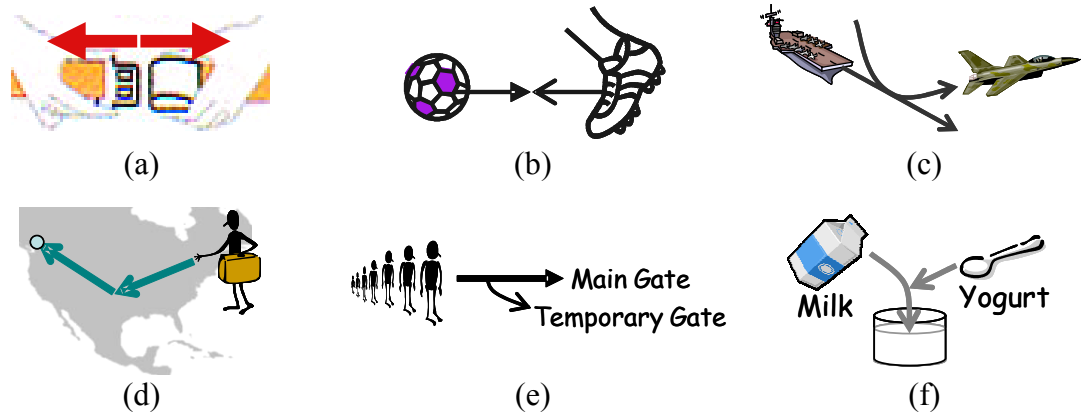

Figure 5.4: Six 2-arrow diagrams with different types of direct links between arrow symbols, which indicate different interactions between the subjects: (a) *separation*, (b) *meeting*, (c) *contact*, (d) *drop-by*, (e) *diversion*, and (f) *confluence*.

#### 5.2.4. Illustrating an Extent Change

A set of arrow symbols that originate from the same component and point in various directions may jointly capture the diffusion or expansion of this component (Figure 5.5). Conversely, a set of arrow symbols that point to the same component from various directions may jointly capture the concentration or shrinking of this component. Diffusion and expansion are different concepts, although they correspond to the same formats. Diffusion refers to the mass of spatial movements of subsets or copies of the same subject (Figure 5.5a). Naturally, the common component must be a collective or replicable entity. On the other hand, expansion refers to a subject's change with regard to its shape and, therefore, the common component must be a transformable entity (Figure 5.5b). Similarly, concentration and shrinking are not equivalent, although they correspond to the identical formats.



Figure 5.5: Two multi-arrow diagrams in which a group of arrow symbols is used for illustrating (a) the diffusion of balloons and (b) the expansion of a balloon.

### 5.2.5. Specifying an Interval

A pair of arrow symbols, which faces away from each other, may be used for illustrating an interval (Figure 5.6a). In this case, the two arrow symbols originate from the same label that represents something to which the interval is assigned (Figure 5.6a), interval name (Figure 5.6b), or the scale of the interval. Bi-directional arrow symbols are used for the same purpose (Figure 5.6a). In addition, if the interval is too narrow to put two arrow symbols and a label between them, arrow symbols are arranged to sandwich the interval from both sides (Figure 5.6b).

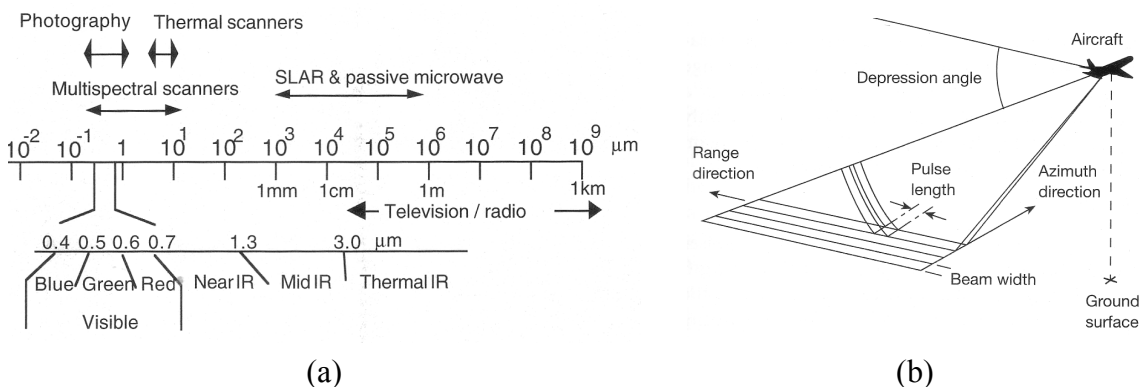

Figure 5.6: Two multi-arrow diagrams in which a pair of reversely directed arrow symbols is used for specifying the interval of (a) wavelength of electric waves assigned to televisions and radios and (b) a pulse (1997).

### 5.3. Nesting of Arrow Diagrams

The spatial arrangement of arrow symbols is exploited not only for organizing a group of arrow symbols, but also for nesting arrow diagrams. In a nested arrow diagram, some arrow symbols refer to its sub-diagrams, each of which forms an arrow diagram by itself (Figure 5.7). Such sub-diagrams are called the *subordinate arrow diagram* in the nested arrow diagrams.

Just like an icon or a text label, a subordinate arrow diagram serves as a component for the arrow symbol that refers to this subordinate arrow diagram. Thus, the middle arrow symbol in Figure 5.7a, for instance, organizes an individual structure (“*El Niño*”, “*Fish catch* ↓”). Since the subordinate arrow diagram “*Fish catch* ↓” captures an event where the fish catch decreases, the individual structure has a pattern of ( $PC_O$ ,  $-$ ,  $PC_E$ ). This pattern corresponds to *behavioral description* and *association* (Section 4.4). Thus, the middle arrow symbol may capture the (spatial) transition of “*El Niño*” to get involved into “*Fish catch* ↓” or associates “*El Niño*” and “*Fish catch* ↓.” In this way, an arrow diagram may capture a complicated scenario by nesting the diagram.



Figure 5.7: (a) The central arrow symbol points to “*Fish catch*,” but conceptually refers to the subordinate arrow diagram “*Fish catch* ↓”; and (b) the central arrow symbol points to the horizontal arrow symbol, but conceptually refers to the subordinate arrow diagram “*Rural area* → *Urban area* .”

If a multi-arrow diagram is nested, the arrow symbol  $a^*$ , which refers to a subordinate arrow diagram  $d_{\text{sub}}$ , either originates from or points to the center of  $d_{\text{sub}}$ , such that the diagram reader would notice that  $a^*$  refers to entire  $d_{\text{sub}}$  instead of a part of  $d_{\text{sub}}$ . Accordingly,  $a^*$  apparently has an indirect link (Figure 5.7a) or a direct link (Figure 5.7b) with the arrow symbol in  $d_{\text{sub}}$ .

#### 5.4. Interpretation of Arrow Symbols in Multi-Arrow Diagrams

In a multi-arrow diagram, interpreting arrow symbols means deducing both semantic roles of individual arrow symbols (i.e., individual roles) and those of arrow symbol groups (i.e., group roles). Different orders of these two deduction processes yield the following two approaches:

- in the *bottom-up approach* the deduction of individual roles proceeds the deduction of group roles, and
- in the *top-down approach* the deduction of individual roles follows the deduction of group roles.

Some group roles presume that arrow symbols in the group also have a specific individual role (Table 5.1). Thus, it is straightforward to deduce individual roles before deducing group roles (i.e., the bottom-up approach). The bottom-up approach is, however, inefficient in the diagram where some arrow symbols refer to components indirectly and such indirect reference becomes evident after the deduction of group roles. For instance, in Figure 5.3a, the horizontal arrow symbol indirectly refers to the process “*Search the*



*address book for the given name.*” This indirect reference is detected after figuring out that the arrow symbols jointly formulate a branching process. In the bottom-up approach the individual roles of arrow symbols are deduced without the information about such indirect reference and, accordingly, may yield incorrect interpretations at first. Since such incorrect interpretations must be corrected afterwards, the bottom-up approach becomes inefficient.

Table 5.1: Individual roles of arrow symbols presumed by their group role.

Group Role	Assumed Individual Roles
<i>formulating a branching process</i>	<i>association (illustrating a temporal order)</i>
<i>indicating interactions of subjects during their transitions</i>	<i>behavioral description</i>
<i>illustrating diffusion/ expansion / concentration / shrinking</i>	<i>behavioral description</i>

The top-down process avoids such inefficient interpretation process. A top-down approach is possible by deducing the group roles tentatively, assuming a hypothetical individual role on each arrow symbol, if necessary. The actual interpretation process proceeds as follows:

Step 1: Subordinate arrow diagrams (Section 5.3) are detected.

Step 2: The group roles of arrow symbols, except those in the subordinate diagrams, are deduced tentatively, assuming that each arrow symbol has a specific individual role, if necessary.

Step 3: Individual role of each arrow symbol is deduced, considering the indirect references of arrow symbols specified by the tentative group roles.

Step 4: The tentative group roles are rejected if the individual roles assumed in Step 2 are inconsistent with the individual roles deduced in Step 3.

The following four sections explain each of these four steps.

#### **5.4.1. Detection of Subordinate Arrow Diagrams**

Let a given multi-arrow diagram be  $d$ . In Step 1, the candidates for  $d$ 's subordinate arrow diagrams are detected as  $d$ 's sub-diagrams, which satisfy the following conditions:

C1: The sub-diagram consists of a subset of the arrow symbols in  $d$  and all components to which these arrow symbols refer, thereby forming an arrow diagram by itself.

C2: The sub-diagram is *connected* (i.e., it cannot be divided into two sub-diagrams, each of which satisfies C1).

C3: The sub-diagram has a valid interpretation as an arrow diagram.

C4: One of  $d$ 's arrow symbols, except those in the sub-diagram, either points to or originates from the sub-diagram's center.

#### **5.4.2. Tentative Deduction of Group Roles**

In Step 2, the group roles of arrow symbols are tentatively deduced. The deduction is primarily based on the spatial arrangement of arrow symbols, since such arrangement

contributes to the group organizations of arrow symbols (Section 5.2). Table 5.2 shows the spatial arrangements of arrow symbols that correspond to the group roles introduced in Section 5.2. Each arrangement in Table 5.2 essentially works as the requirement for a set of arrow symbols to have each group role. The presence or absence of each arrangement in the given arrow diagram is judged mostly from the diagram's inter-arrow structure, which captures the links between the arrow symbols in the diagram (Section 3.3). Some arrangements may correspond to more than one group role and, accordingly, yield multiple candidates for the group roles. For instance, two arrow symbols with a direct body-tail link correspond to both *formulating a branching process* and *illustrating interactions of subjects*.

Table 5.2: Spatial arrangements required for the arrow symbols with the group roles in Section 5.2.

Group Role	Required Spatial Arrangement
<i>indicating element-sharing</i>	arrow symbols with indirect link(s)
<i>formulating a branching process</i>	an arrow symbol $a^*$ and other arrow symbols, each with a direct tail-body link with $a^*$ and no other links
<i>indicating interactions of subjects during their transitions</i>	arrow symbols with direct link(s)
<i>illustrating diffusion / expansion</i>	many arrow symbols with indirect tail-tail links
<i>illustrating concentration / shrinking</i>	many arrow symbols with indirect head-head links
<i>specifying an interval</i>	(a) Two arrow symbol, facing away from each other, with an indirect tail-tail link and no other links (b) Two arrow symbols, facing each other, with no links and a short distance between them

In addition, some group roles have additional requirements for the component to which all arrow symbols in the group refer (Table 5.3). Such requirements may be useful for narrowing down the candidates for the group roles.

Table 5.3: Components required for the arrow symbols with the group roles in Section 5.2.

Group Role	Required Components
<i>illustrating diffusion</i>	a collective or replicable entity
<i>illustrating concentration</i>	a collective entity
<i>illustrating expansion / shrinking</i>	a transformable entity
<i>specifying an interval</i>	a label showing the interval's owner or scale

In the actual process, the tentative group roles are deduced as follows. For each group role, every pair of arrow symbols, except the arrow symbols in subordinate arrow diagrams, is examined for satisfaction of the requirements in Tables 5.2 and 5.3. If so, this role is adopted as the candidate for the group role of this pair. Afterwards, it is examined whether there is any set of mutually-linked arrow symbols for which every pair has the same group role. If so, this group role is reassigned to the set of these arrow symbols.

### 5.4.3. Deduction of Individual Roles

In Step 3, the individual role of each arrow symbol is deduced by the same process as the interpretation of arrow symbols in 1-arrow diagrams (Section 4.5), because even in multi-arrow diagrams the semantic role of each arrow symbol is established by its individual structure. This deduction process, however, must consider the components to which the arrow symbol indirectly refers. Some group roles specify such indirect reference of arrow symbols (Table 5.4).

Table 5.4: Indirect reference of arrow symbols specified by the group roles in Section 5.2.

Group Role	Indirect Reference
<i>formulating a branching process</i>	all arrow symbols indirectly refer to the same tail component, to which only one arrow symbol ( $a^*$ ) directly refer by its tail
<i>indicating drop-by</i> (a subclass of <i>indicating interactions of subjects during their transitions</i> )	both arrow symbols refer to the same subject
<i>indicating diversion</i> (a subclass of <i>indicating interactions of subjects during their transitions</i> )	one arrow symbol refer to the part of the subject assigned to another arrow symbol

### 5.4.4. Validation of Tentative Group Roles

Step 2 may have assumed that each arrow symbol has a certain individual role, which is specified by the tentative group role (Table 5.1). If the individual role of each arrow symbol assumed in Step 2 is inconsistent with the individual role deduced in Step 3, the

tentative group role is incorrect and, accordingly, rejected. Otherwise, the tentative group role is adopted as the valid interpretation.

## 5.5. Demonstration

This section demonstrates with two examples (Figure 5.8) how the developed method for interpreting arrow symbols in multi-arrow diagrams (Section 5.4) works. These examples are identical to those used in Section 3.4 for demonstrating two complementary structures of arrow diagrams.

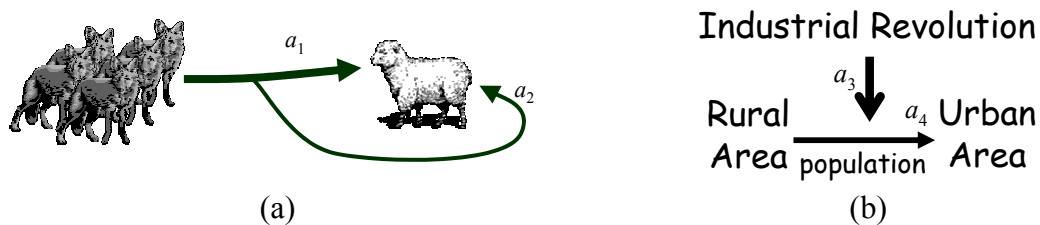

Figure 5.8: Two 2-arrow diagrams which capture (a) a pack of wolves splits into two packs, which approach a sheep from front and behind and (b) the industrial revolution leads to the population drift from rural area to urban area.

### 5.5.1. Example 1: Wolves' Attack Scenario

The 2-arrow diagram in Figure 5.8a has two sub-diagrams, “*wolves*→*sheep*” and “*sheep*←,” which are associated with the arrow symbols  $a_1$  and  $a_2$ , respectively. The sub-diagram “*wolves*→*sheep*” cannot be a subordinate arrow diagram, since  $a_2$  points not the center of “*wolves*→*sheep*.” Similarly, “*sheep*←” cannot be a subordinate arrow

diagram, since  $a_1$  points not to the center of “*sheep*←.” Consequently, the 2-arrow diagram is not nested.

Since  $a_1$  and  $a_2$  have a direct body-tail link and an indirect head-head link,  $a_1$  and  $a_2$  may have a group role of *indicating element-sharing* (of the sheep) and *indicating diversion* (of the wolves) (Table 5.2). If *indicating diversion* is the correct interpretation, the individual roles of  $a_1$  and  $a_2$  should be *behavioral description* (Table 5.1) and the subject associated with  $a_1$  should be succeeded to  $a_2$  (Table 5.3). Consequently, the individual structures of  $a_1$  and  $a_2$  are (*wolves*, –, *sheep*) and (a part of *wolves*, –, *sheep*), respectively. The patterns of these two structures are both ( $PC_O$ , –,  $PC_O$ ), which correspond to *behavioral description* (Table 4.3) and *association* (Table 4.6). Consequently, *indicating diversion* is not rejected and it is deduced that both  $a_1$  and  $a_2$  have the individual role of *behavioral description* and they jointly have group roles of *indicating diversion* and *indicating element-sharing*.

### 5.5.2. Example 2: Industrial Revolution Scenario

The 2-arrow diagram in Figure 5.8b has two sub-diagrams, “*Industrial revolution*” and  
↓  
 “*Rural area* → *Urban area*,” which are associated with the arrow symbols  $a_3$  and  $a_4$ ,  
*population*  
 respectively. “*Rural area* → *Urban area*” satisfies all requirements for a subordinate  
*population*  
 arrow diagram.

Assume “*Rural area* → *Urban area*” is not a subordinate arrow diagram. Then, since  $a_3$  and  $a_4$  have a direct head-body link,  $a_3$  and  $a_4$  may have a group role of *indicating confluence*. If *indicating confluence* is the correct interpretation, the individual roles of  $a_3$  and  $a_4$  should be *behavioral description* (Table 5.1), but it is impossible, because “*Industrial Revolution*” cannot get together with the “*population*.” Consequently, *indicating confluence* is an invalid interpretation. On the other hand, if  $a_3$  and  $a_4$  are not jointly used for *indicating confluence*, their direct head-body link cannot be explained. Consequently, “*Rural area* → *Urban area*” must be a subordinate arrow diagram.

The individual structure of  $a_4$ , (“*Rural Area*”, “*population*”, “*Urban Area*”), has a pattern of  $(PC_L, PC_O, PC_L)$ , which corresponds to *behavioral description* (Table 4.3). Accordingly,  $(\text{"Industrial revolution", -, "Rural area"} \rightarrow \text{"Urban area"})$ , has a pattern of  $(PC_E, -, PC_E)$ , which corresponds to *behavioral description* (Table 4.3) and *association* (Table 4.6). *Behavioral description* is an impossible interpretation, however, since “*Industrial Revolution*” is not something that approaches the population drift event or changes into this event. Consequently,  $a_3$  is used for *association*—implying that the industrial revolution causes or contributes to the population drift from the rural area to the urban area.



## 5.6. Summary

In multi-arrow diagrams, an arrow symbol may refer to subordinate arrow diagrams, which are subsets of the multi-arrow diagrams. In addition, arrow symbols in multi-arrow diagrams may organize a group under a specific spatial arrangement and jointly have the following group roles:

- to indicate that a set of individual semantics refers to the same component,
- to formulate a branching process,
- to indicate interactions of subjects during their transitions,
- to illustrate an entity's extent change, and
- to specify an interval.

Thanks to such nesting and the group roles of arrow symbols, multi-arrow diagrams capture richer semantics than a set of 1-arrow diagrams. This chapter developed a method for interpreting arrow symbols in such multi-arrow diagrams, which consisted of the four steps: (1) detection of subordinate arrow diagrams, (2) tentative deduction of group roles, (3) deduction of group roles, and (4) validation of the tentative group roles. The spatial arrangements of arrow symbols were exploited for detecting subordinate arrow diagrams, as well as for deducing group roles of arrow symbols.

## Chapter 6

### EVALUATION

This thesis has developed an algorithm for deriving the interpretations of arrow symbols, which is called the *Arrow Symbol Interpreter (ASI)*. This method emphasizes structural patterns of arrow diagrams under the hypothesis that the interpretation method, which deduces interpretations from the spatial arrangement of arrow symbols and components in arrow diagrams, detects the correct semantic roles of arrow symbols at a significantly higher rate than random choices (Section 1.3). To examine this hypothesis this chapter conducts an experiment, in which a prototype system, which implements the algorithm in Section 4.5, deduces the semantic roles of individual arrow symbols in the sample arrow-containing diagrams. Then, the correctness of the computer-generated interpretations is statistically evaluated. The detailed design of the experiment is described in Section 6.1. Section 6.2 shows the result of this experiment, from which Section 6.3 evaluates the hypothesis. Section 6.4 further analyzes the result of this experiment with a focus on each class of semantic roles. Finally, Section 6.5 analyzes the misinterpreted arrow symbols in order to find out problems in the current *ASI*.

#### 6.1. Method

The purpose of this experiment is to examine the correctness of the interpretations of arrow symbols deduced by the *ASI*. The experiment features the algorithm for deducing

possible semantic roles of individual arrow symbols (i.e., individual roles) from the pattern of their individual structures, because this algorithm is well-formalized (Section 4.5) and commonly used in the interpretations of arrow symbols in 1-arrow diagrams and those in multi-arrow diagrams.

Figure 6.1 shows a screenshot of the prototype system, which has been developed for the experiment. The prototype deduces the set of all semantic roles (*orientation, behavioral description, annotation, association, or their combinations*) that corresponds to a given individual structure. At this time, the user of this prototype has to specify the pattern of the individual structure associated to the arrow symbol. The automation of this process is a subject for future research (Section 7.3.2).

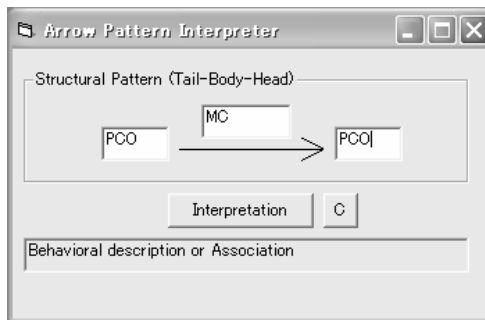

Figure 6.1: A prototype of the *ASI*.

Sample arrow symbols for the experiment were collected from an introductory GIS textbook, “*Geographical Information Systems and Computer Cartography*” (Jones 1997), because this material satisfies the following conditions:

- the material contains a sufficient number of arrow-containing diagrams;
- the semantic roles of arrow symbols in these diagrams are not biased (Figure 6.2);

- the material is expected to be read by people without special education or training in diagram reading; and
- the material matches the interest of the readers whom this thesis targets.

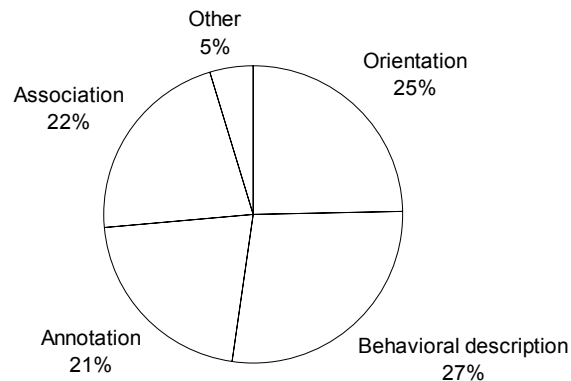

Figure 6.2: Semantic roles of 304 sample arrow symbols found in a GIS textbook (Jones 1997).

We also examined two introductory textbooks in biology and astronomy, but the semantic roles of the arrow symbols used in these two textbooks are considerably biased, because the biology textbook predominantly uses arrow symbols for illustrating chemical reactions or movement of organisms, both of which belong to *behavioral description* (Figure 6.3a), while the astronomy textbook often uses arrow symbols for illustrating an interval, which cannot be categorized into the four classes of semantic roles (Figure 6.3b). From these two examples, we considered that the materials in traditional domains, which may follow the diagrammatic conventions in those domains, are not preferable for the source of sample arrow symbols. Also, newspapers and magazines were avoided, since their diagrams are typically drawn by few designers and adhere to in-house standards.

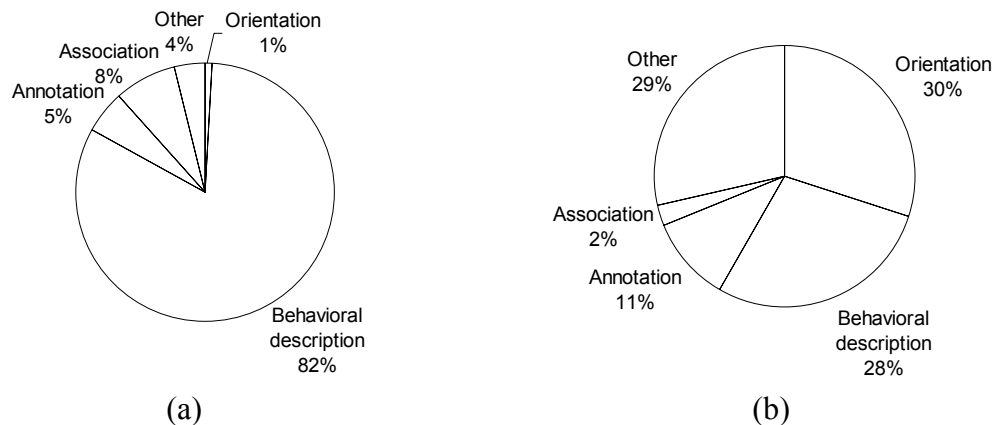

Figure 6.3: Semantic roles of (a) 745 arrow symbols found in a biology textbook (Comins and Kaufmann III 2003), Part I and II, and (b) 956 arrow symbols found in an astronomy textbook (Avila 1992).

The correct semantic role of each arrow symbol in the textbook figures was assigned based on the figures plus context, sometimes drawn from the caption and the body text. We confirmed that the assignment of the correct semantic roles to the arrow symbols correspond to the result of votes by human subjects.

From the figures in the GIS textbook 64 arrow-containing diagrams with 304 arrow symbols were collected. Among the 64 diagrams, 53 diagrams contain multiple arrow symbols. Some diagrams contain a large number of similar arrow symbols, which have the same semantic roles and the same patterns of individual structures (Figure 6.4). These similar arrow symbols, if counted individually, may distort the statistic result. Thus, for every set of similar arrow symbols in each diagram one representative is selected. Finally, 94 representative arrow symbols were prepared for the experiment.

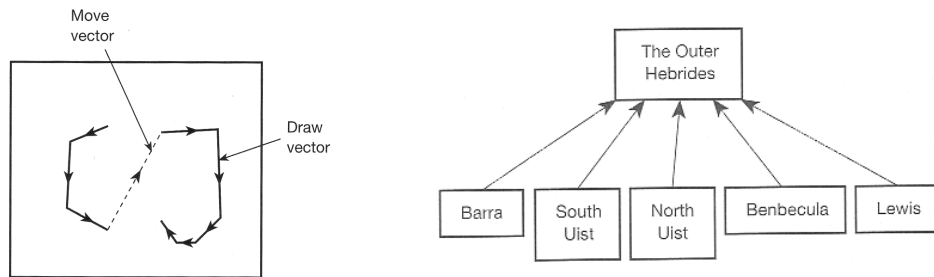

Figure 6.4: Two arrow-containing diagrams with a set of similar arrow symbols.

Figure 6.5 shows the semantic roles of the 94 representative arrow symbols. The selection of representatives did not bias the proportion of the four classes of semantic roles

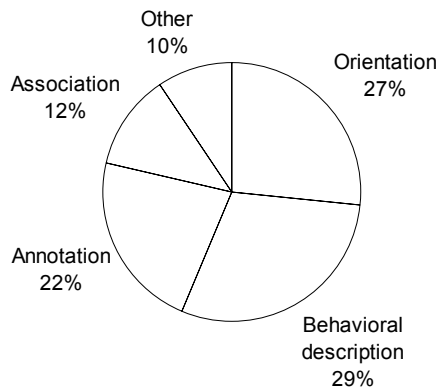

Figure 6.5: Semantic roles of the 94 representative arrow symbols.

The evaluation starts with counting the number of interpretations that the *ASI* deduced. Then, for every arrow symbol, the correctness of the deduced interpretations is examined, based on the distinction of the following four categories of correctness:

- *exact match*, where the *ASI* deduced only one interpretation that is exactly the correct semantic role;

- *partial match*, where the *ASI* deduced multiple interpretations one of which is the correct semantic role;
- *oversight*, where the *ASI* deduced zero, one, or multiple interpretations, but these interpretations do not include the correct semantic role, which belongs to one of the four classes of semantic roles (i.e., *orientation*, *behavioral description*, *annotation*, or *association*); and
- *no-answer*, where the *ASI* deduced zero, one, or multiple interpretations, but these interpretations do not include the correct semantic role, because the correct semantic role belongs to none of the four classes of semantic roles.

Then, the numbers of sample arrow symbols whose interpretations yield these four categories are counted. This thesis considers that *ASI* successfully detects the correct semantic role of an arrow symbol if the arrow symbol yields an *exact match* or a *partial match*. Accordingly, the sum of *exact match* and *partial match* cases, divided by the number of all sample arrow symbols, is called the *detection rate*. This thesis calculates the *ASI*'s detection rate and examines if it is significantly larger than the detection rate under random choices.

The experiment results are also analyzed statistically with a focus on each class of semantic roles. For each class of semantic roles (say,  $r_i$ ) the interpretation results are categorized into *true-positive*, *true-negative*, *false-positive*, and *false-negative* results, depending on (1) whether  $r_i$  is the correct semantic role and (2) whether the *ASI*'s

interpretation includes  $r_i$  (Table 6.1). These four categories of results have the following meanings:

- the true-positive result means that the *ASI* successfully deduced  $r_i$ , which is the correct semantic role;
- the true-negative result means that the *ASI* successfully excluded  $r_i$ , which is not the correct semantic role;
- the false-positive result means that the *ASI* unnecessarily deduced  $r_i$ , which is not the correct semantic role; and
- the false-negative result means that the *ASI* failed to detect the correct semantic role  $r_i$ , thereby yielding *oversight*.

Then, the numbers of sample arrow symbols whose interpretation yields these four categories of results are counted. The results are summarized into four  $2 \times 2$  contingency tables, which are then evaluated with *Fisher's exact test* to examine a hypothesis that the *ASI's* conclusion on whether a semantic role  $r_i$  may be the correct semantic role or not is related to whether  $r_i$  is actually the correct semantic role or not.

Table 6.1: Four types of interpretation result with regard to a semantic role  $r_i$ .

		Whether the <i>ASI's</i> interpretations include $r_i$	
		Yes	No
Whether correct semantic role is $r_i$	Yes	true-positive	false-negative
	No	false-positive	true-negative



Finally, the misinterpreted arrow symbols (i.e., arrow symbols whose interpretation yields *partial match*, *oversight*, or *no-answer*) are analyzed in order to find out problems in the current *ASI*.

## 6.2. Statistical Overview

Figure 6.6 shows the number of interpretations that the *ASI* deduced for the 94 arrow symbols. In most cases the *ASI* deduces one or two interpretations. This result indicates that *ASI* certainly removes the ambiguity of arrow symbols, since initially there are four interpretation choices (i.e., *orientation*, *behavioral description*, *annotation*, and *association*). For 6% of the arrow symbols the *ASI* was unable to deduce interpretations, due to the use of irregular formats (Section 6.5.1) or new formats that correspond to the unexpected semantic roles (Section 6.5.3). On average, 1.31 interpretations are deduced per arrow symbol.

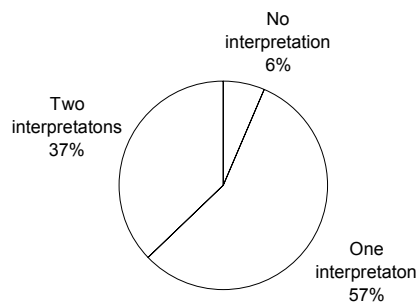

Figure 6.6: The number of interpretations that the *ASI* deduced for the 94 representative arrow symbols.

Figure 6.7 shows the correctness of the *ASI*'s interpretations. For  $44\% + 35\% = 79\%$  of the 94 arrow symbols, the *ASI* successfully detected the correct semantic role.

Especially, 44% of the 94 arrow symbols yielded a unique interpretation, which requires no further process for narrowing down the interpretations. For  $11\% + 10\% = 21\%$  of the 94 arrow symbols, the *ASI* failed to detect the correct semantic roles. The 10% of the 94 arrow symbols failed the detection because their correct semantic roles are not among *orientation*, *behavioral description*, *annotation*, and *association*.

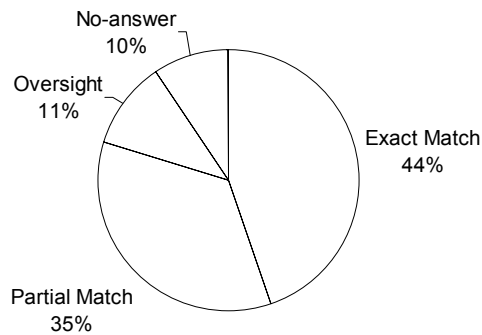

Figure 6.7: The interpretation results of the 94 representative arrow symbols.

### 6.3. Validity of the Hypothesis

The hypothesis of this thesis is that the interpretation method, which deduces interpretations from the spatial arrangement of arrow symbols and components in arrow diagrams, detects the correct semantic roles of arrow symbols at a significantly higher rate than random choices (Section 1.3). The interpretation method used for the experiment is the *ASI*. According to the previous statistical result, the *ASI* detected the correct semantic roles (i.e., the *ASI*'s interpretations include the correct semantic roles) for 79% of sample arrow symbols, even though the average number of the interpretations is only 1.31 per arrow symbol. If zero, one, or two interpretations are randomly selected from four choices at the probability of 6%, 57%, and 37%, respectively (Figure 6.6), the

expected detection rate (i.e., the probability that the randomly-selected interpretations for an arrow symbol include its correct semantic role) is only 30%, which is much smaller than the *ASI*'s detection rate. In addition, the probability that such randomly-selected interpretations include the correct semantic roles for 79% of 94 arrow symbols is only  $9.7 \times 10^{-24}$ . This result clearly supports the hypothesis that the *ASI* detects the correct semantic roles at a significantly higher rate than random choices. This result indicates that the *ASI*'s interpretation is reliable, at least more than randomly-selected interpretations.

#### **6.4. Statistical Analysis in Terms of Each Class of Semantic Roles**

Tables 6.2-6.5 summarize the interpretation results of the 94 arrow symbols with regard to each class of semantic role. The comparison of these tables reveals that:

- The interpretations with regard to *annotation* are highly accurate (Table 6.4);
- Interpretations with regard to *orientation* and *behavioral description* are slightly error-prone; that is, they are occasionally deduced unnecessarily and occasionally undetected (Tables 6.2 and 6.3); and
- *Association* is detected with few omissions, but at the same time often deduced unnecessarily (Table 6.5).

Table 6.2: The interpretation results of the 94 arrow symbols with regard to *orientation*.

		Whether the <i>ASI</i> 's interpretations include <i>orientation</i>		Total
		Yes	No	
Whether the correct semantic role is <i>orientation</i>	Yes	19	6	25
	No	6	63	69
Total		25	69	94

Table 6.3: The interpretation results of the 94 arrow symbols with regard to with regard to *behavioral description*.

		Whether the <i>ASI</i> 's interpretations include <i>behavioral description</i>		Total
		Yes	No	
Whether the correct semantic role is <i>behavioral description</i>	Yes	25	3	28
	No	10	56	66
Total		35	59	94

Table 6.4: The interpretation results of the 94 arrow symbols with regard to with regard to *annotation*.

		Whether the <i>ASI</i> 's interpretations include <i>annotation</i>		Total
		Yes	No	
Whether the correct semantic role is <i>annotation</i>	Yes	21	0	21
	No	2	71	73
Total		23	71	94

Table 6.5: Number of the four types of interpretation results with regard to *association*.

		Whether the <i>ASI</i> 's interpretations include <i>association</i>		Total
		Yes	No	
Whether the correct semantic role is <i>association</i>	Yes	10	1	11
	No	30	53	83
Total		40	54	94

These four tables are evaluated with Fisher's exact test, which statistically examines the significance of the dependence between two nominal variables in a  $2 \times 2$  contingency table (Fisher 1922). Under the null hypothesis that two variables are independent, products of the marginal probabilities determine the probabilities that each type of interpretation result occurs (Table 6.6). Consequently, we can accurately calculate the probability  $p$  that the frequency in a certain cell becomes less than or equal to the observed frequency under the condition of fixed marginal frequencies. If  $p$  is significantly small, the null hypothesis is rejected and, accordingly, the alternative hypothesis that two variables are dependent is supported.

Table 6.6: Probability that each interpretation result with regard to a semantic role  $r_i$  occurs if two nominal variables are independent.

		Whether the <i>ASI</i> 's interpretations include $r_i$		Total
		Yes	No	
Whether the correct semantic role is $r_i$	Yes	$xy$	$x(1-y)$	$x$
	No	$(1-x)y$	$(1-x)(1-y)$	$(1-x)$
Total		$y$	$(1-y)$	1

The calculated  $p$  that the frequency of the false-negative results is less than or equal to the observed frequency is  $5.2 \times 10^{-10}$ ,  $9.1 \times 10^{-12}$ ,  $5.3 \times 10^{-19}$ , and  $6.6 \times 10^{-4}$  for Tables 6.2-6.5, respectively. Thus, for all four tables the null hypothesis is rejected at the 1% level of significance. This result indicates that the *ASI*'s conclusion on whether a semantic role  $r_i$  may be the correct semantic role or not is significantly related to whether  $r_i$  is actually the correct semantic role or not. Interestingly,  $p$  for Table 6.6 is much larger than others, indicating the *ASI*'s weak detection power with regard to *association*.

## **6.5. Analysis of Misinterpretations**

In order to achieve a practical level of the interpretations, however, higher detection rate and smaller number of unnecessary interpretations are still desirable. In order to find the directions for improving the *ASI*, this section analyzes the sample arrow symbols whose interpretation yields *oversight*, *partial match*, or *no-answer*.

### **6.5.1. Oversight**

*Oversight* occurred for eleven arrow symbols out of the 94 samples. Among these eleven arrow symbols, six, four, and one corresponded to the failure to detect *orientation*, *behavioral description*, and *association*, respectively.

The common reason why the *ASI* failed to detect *orientation* was the use of unexpected formats. For instance, in Figure 6.8a, an adverbial component “*Azimuth*

*direction*” is placed in front of the arrow symbol, even though this thesis has assumed that adverbial components are located in the arrow symbol’s body slot (Section 4.3.2). Similarly, in Figure 6.8b, each arrow symbol refers to two locations, even though this thesis has assumed that an arrow symbol for *orientation* refers to at most one location (Section 4.2.1). Incorporating such additional formats into the current set of basic formats for *orientation* (Figure 4.3) will improve the *ASI*’s ability to detect *orientation*.

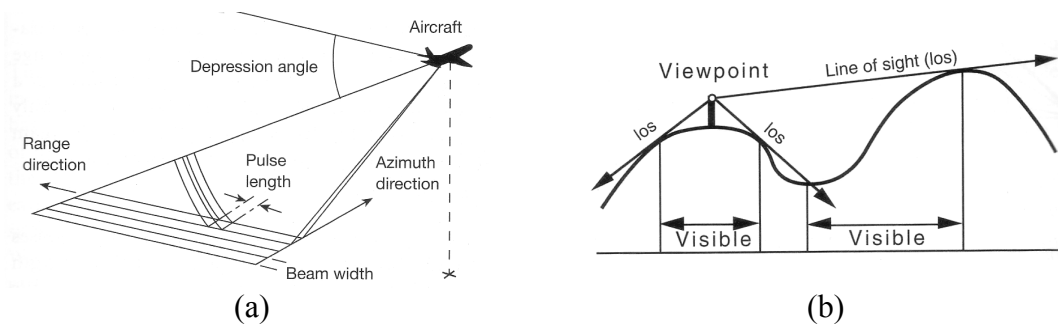

Figure 6.8: Two arrow-containing diagrams in which arrow symbols are used for *orientation* in irregular formats: (a) the arrow symbol points to an adverbial component “*Azimuth direction*” and (b) each arrow symbol refers to two locations.

The common reason why the *ASI* failed to detect *behavioral description* was the omission of the subject (Figure 6.9). The subject of *behavioral description* is omitted typically when it is obvious from the context. In such case, the diagram caption may be useful for detecting the omitted subject.

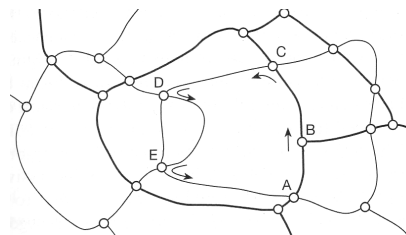

Figure 6.9: An arrow-containing diagram in which arrow symbols are used for *behavioral descriptions*, although the subjects are not illustrated in the diagrams.

Figure 6.10 shows the case where the *ASI* failed to detect *association*. The white arrow symbol indirectly refers to the empty table in the previous line, thereby associating the empty table with the subsequent table of settlements. Like this example, an arrow symbol may be placed at a line head and associate an element in the previous line with the subsequent element. This spatial arrangement is also seen in the descriptions of mathematical deductions. The knowledge of such diagram conventions would help us to identify the components to which arrow symbols may indirectly refer.

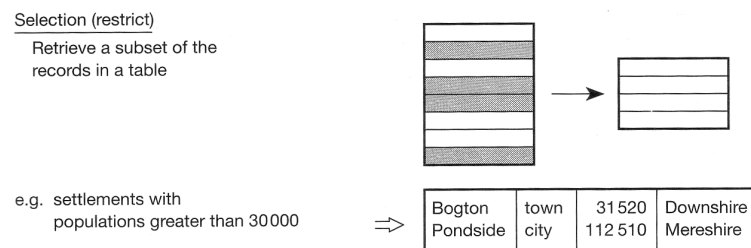

Figure 6.10: An arrow-containing diagram where the white arrow symbol indirectly refers to the empty table in the previous line.

### 6.5.2. Partial Match

Thirty-three arrow symbols out of the 94 samples yielded a *partial match*. For 25 cases the *ASI* deduced the correct interpretation, *behavioral description*, together with an unnecessary interpretation, *association*. For the remaining eight cases the *ASI* deduced the correct interpretation, *association*, together with an unnecessary interpretation, *behavioral description*. Table 6.7 shows the patterns of the individual structures of the 33 arrow symbols, highlighting the large portion of the pattern  $(PC_o[MC]^*$ ,  $[MC]^*$ ,



$PC_o[MC]^*$ ) (24 out of 33 cases). Thus, to resolve the ambiguity of arrow symbols with this pattern is a key for reducing *partial match* results.

Table 6.7: Individual structures of the 33 arrow symbol which yielded *partial match* ( $[MC]^*$ : arbitrary number of  $MC$ ).

Pattern of Individual Structure	Correct Interpretations	Unnecessary Interpretations	Number of Samples
$(PC_o[MC]^*, [MC]^*, PC_o[MC]^*)$			17
$(PC_o[MC]^*, [MC]^*, PC_E[MC]^*)$	<i>behavioral</i>		3
$(PC_o[MC]^*, [MC]^*, PC_o[MC]^*)$	<i>description</i>	<i>association</i>	3
$(PC_E[MC]^*, [MC]^*, PC_L[MC]^*)$			2
$(PC_o[MC]^*, [MC]^*, PC_o[MC]^*)$		<i>behavioral</i>	7
$(PC_o[MC]^*, [MC]^*, PC_L[MC]^*)$	<i>association</i>	<i>description</i>	1

Arrow symbols, whose individual structure has the pattern  $(PC_o[MC]^*, [MC]^*, PC_o[MC]^*)$  are used for capturing the change of a subject, indicating an interaction between a subject and an involved entity (Section 4.2.2), or associating two subjects (Section 4.2.4). The first two correspond to *behavioral description*, while the last one corresponds to *association*. The following three facts are useful for distinguishing these three scenarios:

- An arrow symbol captures the change of a subject only if two objects refer to two different states of the same subject (Figure 6.11a).
- An arrow symbol associates two subjects if both of the two subjects are immovable (Figure 6.11b).

- An arrow symbol typically captures the interaction between a subject and an involved entity if the shape of the arrow symbol is not simple, implying the course of spatial transition.

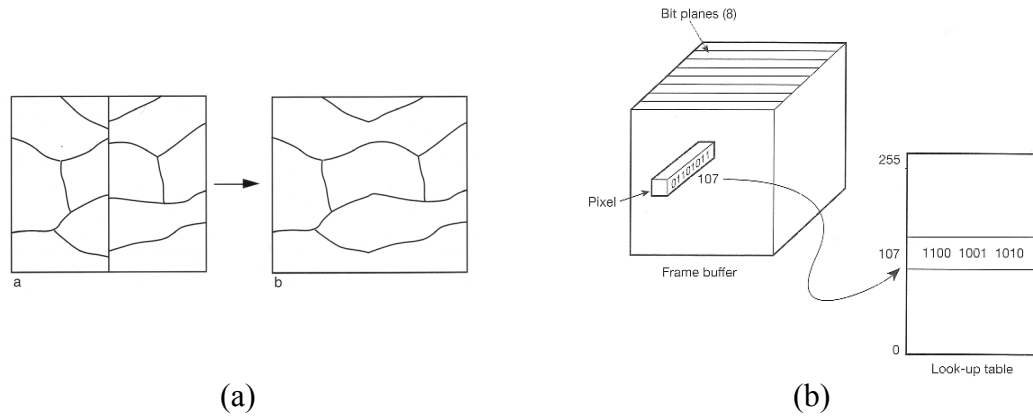

Figure 6.11: Two arrow-containing diagrams, each with an arrow symbol whose individual structure has the pattern of  $(PC_o[MC]^*, [MC]^*, PC_o[MC]^*)$ .

### 6.5.3. No-Answer

For nine arrow symbols out of the 94 samples the *ASI* failed interpretations simply because their semantic roles did not belong to the four classes of semantic roles. These unexpected semantic roles are categorized into the following three types:

- to illustrate an interval, either by itself (Figure 6.12a) or in combination with another reversely directed arrow symbol (Figure 6.12b)—seven cases;
- to highlight a certain point in the space (Figure 6.13a)—one case; and.
- to imply a series of elements ordered by the value of their certain property, such as brightness (Figure 6.13b)—one case;

These additional semantic roles are called *interval specification*, *pointing*, and *gradation*, respectively. Arrow symbols for *pointing* are familiar in computers' graphical user interfaces. *Interval specification* is considered also as a group role when the interval is specified by two arrow symbols (Section 5.2.5).

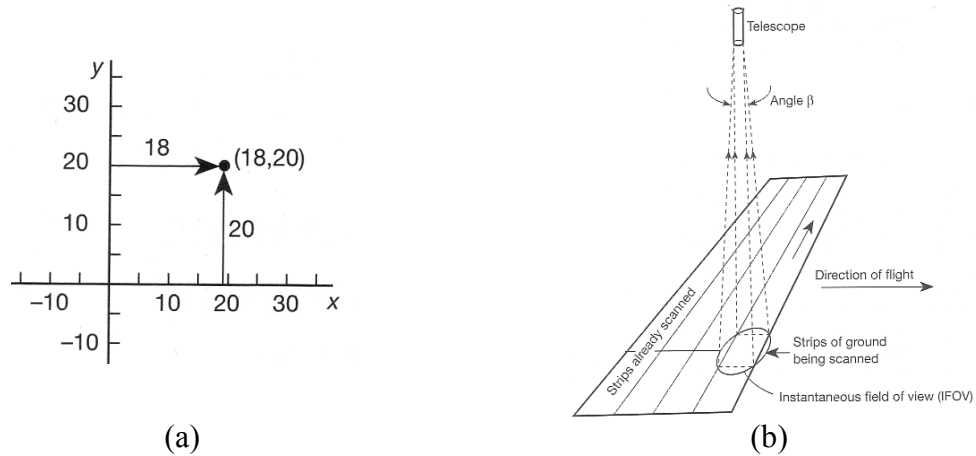

Figure 6.12: Two arrow-containing, in which two arrow symbols are used for *interval specification* (a) by themselves or (b) in combination.

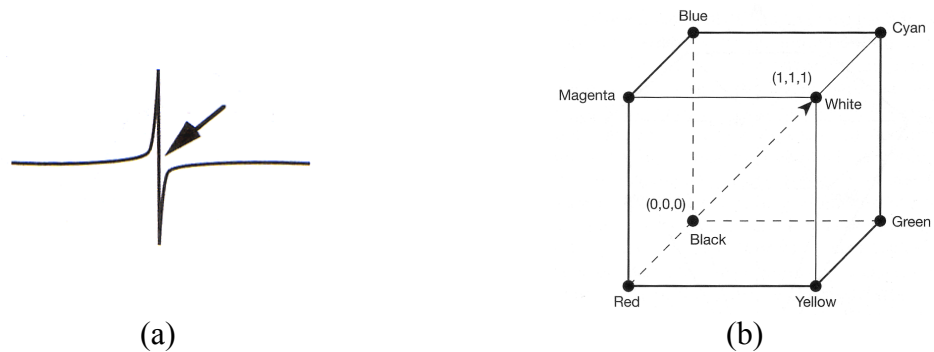

Figure 6.13: Two arrow-containing, each with an arrow symbol used for (a) *pointing* and (b) *gradation*.

It is an open question whether the *ASI* should support these additional semantic roles, because it may be of little merit, while it would increase the risk of *partial match*.

Instead, it might be a better solution to expand the coverage of the current four classes of semantic roles to include those additional semantic roles. For instance, *pointing* can be included in *annotation* by considering that arrow symbols for *annotation* may attach an empty label to a subject.

## 6.6. Summary

This chapter conducted an experiment in which the *ASI*'s prototype interpreted 94 sample arrow symbols. For 79% of the samples the *ASI* successfully detected the correct semantic roles, even though the average number of interpretations was only 1.31. This result supports that the interpretation method, which deduces interpretations from the spatial arrangement of arrow symbols and components in arrow diagrams, detects the correct semantic roles of the arrow symbols at a significantly higher rate than random choices. For 35% of the sample arrow symbols, however, the *ASI* deduced unnecessary interpretations in addition to the correct semantic roles. Background knowledge about, for instance, the components' immobility seems useful for removing such unnecessary interpretations. For 11% of the samples the *ASI* failed to detect the correct semantic roles due to the use of unexpected formats and the omission of subjects. 10% of the samples had semantic roles that the current *ASI* did not support, which are *interval specification*, *pointing*, and *gradation*.

## Chapter 7

### CONCLUSIONS

People often sketch diagrams for communication. If computers understand such diagrams, we can interact with computers more intuitively. Arrow symbols are a fundamental element of such diagrams. They capture a large variety of semantics, as well as enable us to describe dynamic processes and mechanisms in static diagrams. Due to the arrows' versatility, however, it remains a challenging problem to make computers distinguish the various semantic roles of arrow symbols. The solution to this problem is highly desirable for more effective and user-friendly computer systems with sketching interfaces.

#### 7.1. Summary of Thesis

This thesis developed an algorithm for deducing the semantic roles of arrow symbols, called the Arrow Symbol Interpreter (*ASI*). The *ASI* emphasized the structural patterns of arrow-containing diagrams, since the diagram follows a specific spatial arrangement to capture certain semantics. Since the semantic roles of arrow symbols are assigned to individual arrow symbols and sometimes to the groups of arrow symbols, two types of the corresponding structures were introduced: the *individual structure* models the spatial arrangement of components around each arrow symbol and the *inter-arrow structure* models the spatial arrangement of multiple arrow symbols. The semantic roles assigned to individual arrow symbols were classified into four types, and for each class the

corresponding formats of individual structures were identified. The result enabled the derivation of the possible semantic roles of individual arrow symbols. In addition, for the diagrams with multiple arrow symbols, the patterns of their inter-arrow structures were exploited to detect the groups of arrow symbols that jointly have certain semantic roles, as well as the nesting relations between the arrow symbols. The assessment showed that for 79% of the sample arrow symbols the *ASI* successfully detected their correct semantic roles, even though the average number of interpretations was only 1.31. This result indicated that the structural information is highly useful for deriving the reliable interpretations of arrow symbols.

## **7.2. Results and Major Findings**

### **7.2.1. Classification of Individual Roles**

Based on the survey of various arrow-containing diagrams, semantic roles assigned to individual arrow symbols (i.e., individual roles) were classified into *orientation*, *behavioral description*, *annotation*, and *association*. The *ASI* was built on this classification. The experiment, however, revealed such additional semantic roles as *interval specification*, *pointing*, and *gradation*.

### **7.2.2. Investigation of Group Roles**

This thesis also investigated the following semantic roles which are assigned to groups of arrow symbols (i.e., group roles): *indicating element-sharing, formulating a branching process, indicating interactions of subjects during their transitions, illustrating an extent change, and specifying an interval.*

### **7.2.3. Two Syntactic Structures of Arrow Diagrams**

An arrow symbol aligns the components as well as makes a formation with other arrow symbols, thereby establishing a syntactic structure within the diagram. The patterns of such syntactic structures are important for the interpretation, since arrow diagrams follow a specific spatial arrangement to capture the semantics. This thesis, therefore, introduced two types of syntactic structures; *individual structures* modeled the spatial arrangement of components around the individual arrow symbols based on the distinction of three component slots, while the *inter-arrow structures* modeled the spatial arrangement of arrow symbols based on the topological relations between every pair of these arrow symbols. These two structures work complementarily, as they captured the configurations of arrow diagrams from local and global perspectives.

#### **7.2.4. An Algorithm for Deducing Individual Roles of Arrow Symbols**

This thesis identified the correspondence between the individual roles of arrow symbols and the pattern of individual structures, which are determined by both the basic formats that the individual structure must follow and the optional components. Making use of this correspondence, an algorithm for deducing the possible individual roles of arrow symbols was developed. The assessment showed that this method successfully detected the correct individual roles for 79% of sample arrow symbols.

#### **7.2.5. The Arrow Symbol Interpreter (*ASI*)**

Based on the correspondences between the group roles and the spatial arrangement of arrow symbols, a method for deducing the possible groups of arrow symbols and their group role was developed. In addition, an algorithm for detecting subordinate arrow diagrams in multi-arrow diagrams, which also made use of the spatial arrangement of arrow symbols, was developed. By combining the methods for detecting subordinate arrow diagrams, deducing the individual roles, and deducing the group roles, this thesis finally invented an algorithm for deriving both individual roles and group roles of arrow symbols in a multi-arrow diagrams, which consisted of four sequential steps.



### **7.3. Future Work**

This section discusses future work in the four areas: remediation, automation, detail enrichment, and applications.

#### **7.3.1. Remediation**

The analysis of misinterpreted sample arrow symbols revealed some problems in the current *ASI* (Section 6.5). In order to reduce misinterpretations and ambiguous interpretations, this section proposes the following guidelines for the remediation:

##### **7.3.1.1. Reclassification of Individual Roles**

The experiment found that the current four classes of individual roles did not fully cover the individual roles that arrow symbols may have (Section 6.5.3). The classification of individual semantics (Section 4.1) might have emphasized too much the categorization of the semantic roles found in the preliminary reviews (Sections 2.2.1-2.2.7) and lacked a convincing rationale for classifying the entire range of individual roles that arrow symbols potentially have.

An alternative approach would be to reclassify the individual roles of arrow symbols from a viewpoint of *semantic extension* (Langacker 1999). The semantic extension is a cognitive process that people assign a new meaning to a vocabulary by extending its original meaning. There are three mechanisms that trigger the semantic extensions:

- *Metaphor* (Lakoff and Johnson 1980; Lakoff 1987), where a concept succeeds the name of a similar concept. For example, *firewalls* in computer networks succeed its name from *firewalls* in buildings based on the analogy that both firewalls prevent the intrusion of threats. Metaphor is considered a mapping from a source domain to a target domain, such that the target domain is effectively understood by analogy of the well-understood source domain. For example, “*life is a journey*” explains a life (target domain) by a metaphor of journey based on their similarity.
- *Metonymy* (Kovecses and Radden 1998), where a concept succeeds the name of *contiguous* concept. Usually contiguity is such a physical property as spatial proximity and temporal concurrency. For example, in the sentence “*the kettle is boiling,*” the kettle is a metonymy of hot water in the kettle based on their spatial proximity. Metonymy is seen as a cognitive process to access a target by way of another easily-referable source in the same domain.
- *Synecdoche* (Seto 1999), where a concept succeeds the name of either more general or special concept. For example, in the sentence “*click your mouse,*” a mouse button is called *mouse*, which is a more general concept. Conversely, in the sentence “*man shall not live by bread alone,*” food is called *bread*, which is more special concept.

These three types of semantic extensions are driven by people’s cognitive motivations to reduce the memory load for naming a new concept by applying the name of an existing concept (Gyori 2002).

A vocabulary becomes polysemic through iterative semantic extensions. Probably the polysemy of arrow symbols is also explained by such iterative semantic extensions, starting from their most primitive meaning—a flying weapon with a sharp head and a linear body. By tracing this evolution process, the semantic roles (both individual and group roles) of arrow symbols should be schematized as a tree. This tree should rationalize the classification of the semantic roles of arrow symbols. The tree in Figure 7.1 shows a model of evolutions of arrow symbols’ semantic roles, superimposed by the current classification of semantic roles. This tree indicates that *pointing* is fundamentally different from the other classes of semantic roles.

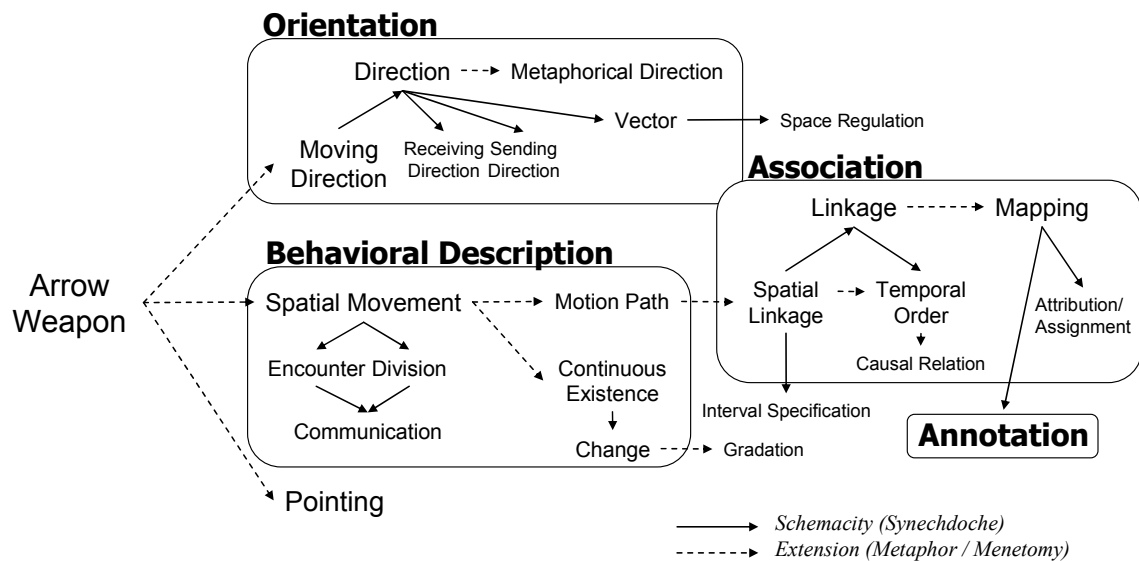

Figure 7.1: A model of evolutions of arrow symbols’ semantic roles.

### 7.3.1.2. Detection of Impractical Interpretations

The *ASI* sometimes deduces an unnecessary interpretation, *behavioral description*, when *association* is the correct semantic role of a given arrow symbol (Section 6.5.2). Such

unnecessary *behavioral description* can be removed making use of background knowledge about the component's immobility. For instance, the three arrow diagrams in Figure 7.2 have the same pattern of individual structures,  $(PC_O, -, PC_{LMC})$ , which correspond to both *behavioral description* and *association*. The arrow symbols in Figures 7.2b-c are, however, not used for *behavioral description* due to the immobility of the broken car and the Brandenburg Gate, respectively.

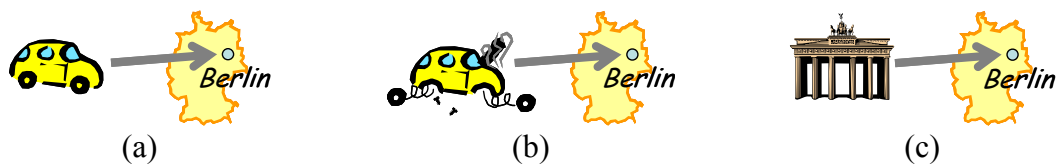

Figure 7.2: Three arrow diagrams whose individual structures has the same patterns,  $(PC_O, -, PC_{LMC})$ , illustrating (a) *behavioral description*, (b) no *behavioral description* due to the immobility of the broken car, and (c) no *behavioral description* due to the (immobile) Brandenburg Gate.

Kurata and Egenhofer (2006b) demonstrated that the component's mobility and immobility can be computationally derived from a general-purpose ontology (Guarino 1998), such as *WordNet* (Fellbaum 1998). First, mobility is often employed already in the definition of an entity class as one of its essential characteristics. For instance, *WordNet* defines *animal* as “*living organism characterized by voluntary movement,*” which clearly indicates the mobility of animals. Second, the mobility of a class may be determined from the operations associated with this class. For instance, *ball*, which *WordNet* defines as “*a round object that is hit or thrown or kicked in games,*” is associated with such operations as *hit*, *throw*, and *kick*. Since *hit*, *throw*, and *kick* are subclasses of the transitive verb *move* (Figure 7.3a), it is considered that the ball has mobility. Finally, mobility is inherited from upper classes to lower classes. Consequently, any subclasses of *animal*,

such as *cat* and *dog*, and any subclasses of *ball*, such as *soccer ball* and *tennis ball*, are also considered movable (Figure 7b).

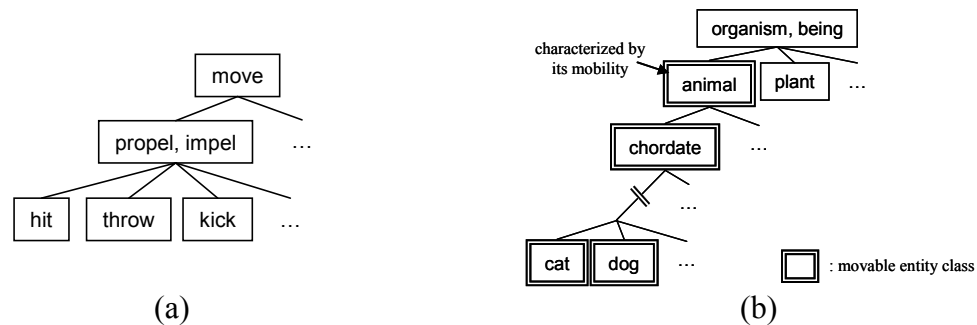

Figure 7.3: (a) Hierarchy of an operation *move* and its subclasses and (b) hierarchy of *animal* and its super/subclasses with inheritance of mobility.

A difficulty arises when determining the lack of mobility (i.e., immobility), since immobility is less recognized as an essential characteristic of an entity class than mobility. A realistic solution is to adopt the closed world assumption (Reiter 1987), that is, to assume that lack of knowledge about its mobility indicates its immobility. For instance, the Brandenburg Gate is considered immovable, because the Brandenburg Gate and its super classes (memorial/monument, structure/construction, artifact/artifact, and so forth) are not characterized by their mobility and have no operation related to *move*. Such inferences rely on the completeness of the ontology and have a risk of unexpected consequences. For example, from WordNet one would misjudge a cloud in the sky to be immovable due to the lack of knowledge about its mobility. Because this problem arises from the incompleteness of WordNet, the use of another ontology may actually reveal the mobility of a cloud. Indeed, *Dictionary.com* defines cloud as “a large moving body of things in the air or on the ground,” which clearly indicates the cloud’s mobility. Such

discrepancies among ontologies imply the merit to employ and mine multiple ontologies concurrently.

In general, the four classes of individual roles require some elements with the following characteristics:

- *Behavioral description* requires a subject to move.
- *Orientation* requires a subject that may have a directional property.
- *Annotation* requires a subject whose property can be specified by the given label.
- *Association* requires two subjects that can be associated under the effective relation.

Thus, if an interpretation requires an element to carry the characteristics that the element actually cannot carry, the interpretation is considered impractical. To realize such judgment of impractical interpretations, the *ASI* should be equipped with a database about the possible characteristics of components *or* a capability of deducing possible characteristics of components from existing knowledge bases. It is left for future research whether the components' characteristics other than mobility can be computationally determined making use of existing knowledge bases.

### **7.3.1.3. Detection of Omitted Components**

An arrow symbol may refer to the components which are not drawn around the arrow symbol, especially when they are obvious from the context (Section 6.5.1). Thus, ideally, the *ASI* should exploit the information from captions and legends in addition to diagrams,

in order to model the context that influences the interpretations of arrow symbols. This problem is a common long-term research goal for the study of diagram understanding.

### **7.3.2. Automation**

This thesis has aimed at the contribution to the development of more intelligent computer systems with sketching interfaces, in which users can naturally explain their ideas and knowledge by sketching a diagram. To facilitate natural interactions in such systems, the process of diagram understanding should be automated as fully as possible. The current *ASI*, however, still requires much of the user's assistance due to the lack of the following abilities:

- Detection of components in diagrams, which requires symbol and text recognition techniques.
- Identification of the component type of the detected components. Some diagrammatic conventions help to make the distinction between primary and modifier components (Section 3.2.3), but further distinction of four subtypes of primary components require a new database about the component type of various components *or* a technique for deducing such component types from existing knowledge bases.
- Judgment on whether each arrow symbol refers to each component and, if yes, which component slot of the arrow symbol contains this component. The distance between

the arrow symbol and the component should be a key for such detection, but it depends on the diagram.

- Identification of the component types that subordinate arrow diagrams (Section 5.3) play. The component type of the subordinate arrow diagram is event if the subordinate diagram illustrates a dynamic process; otherwise, its component type should be classified into object, as it represents a certain static concept.

The development of these techniques is highly desirable for the practical application of the *ASI*. Also, these techniques are necessary for more comprehensive evaluation of the *ASI*, including the deduction of group roles.

### 7.3.3. Detail Enrichment

Another direction of future research is to furnish details to the current interpretations of arrow symbols. The current *ASI* distinguishes only four classes of semantic roles, which might be too coarse for some applications. For instance, the current *ASI* deduces simply that the arrow symbol in Figure 7.4 is used for *behavioral description*, but the illustrated scenario is significantly different depending on whether the car or the traveler is the subject (i.e., which component moves).



Figure 7.4: An arrow diagram that may illustrate two different scenarios depending on the context: a *vehicle approaches a person (encounter)* or a *person leaves a vehicle (division)*.



In general, depending on the relative positions of the subject and the involved entities, subtypes of *behavioral description*, such as *encounter* and *division*, can be distinguished. Similarly, depending on the type of the effective relation, such subtypes of *association* as temporal order, causal relation, and mapping can be distinguished.

#### **7.3.4. Applications**

Applying the *ASI* to actual pen-based systems has two goals. The first goal is to remove the restriction on the use of arrow symbols in the current pen-based systems and improve their usability and effectiveness. The second goal, which is more ambitious, is to contribute to the creation of innovative computer systems with sketching interfaces (and possibly speech interfaces as well), where people may collaborate with computer systems as naturally as people often do in face-to-face communications. Since arrow symbols are fundamentals to paper-based communication that people have enjoyed for hundreds of years, the computer's ability to understand arrow-containing diagrams surely expands the potential of the collaboration by people and computers.

## **GLOSSARY**

### **1-Arrow Diagram**

An arrow diagram that contains a single arrow symbol.

### **Adjective Component**

An optional component of an arrow diagram that is attached to a component and modifies it.

### **Adverbial Component**

An optional component of an arrow diagram that is attached to an arrow symbol and modifies its semantic role.

### **Annotation**

A semantic role of an arrow symbol to attach a label to a subject.

### **Arrow Diagram**

A combination of arrow symbols and the elements to which the arrow symbols refer. Unlike an arrow-containing diagram, every component of an arrow diagram must be referred by at least one of the arrow symbols in the arrow diagram.

### **Arrow Semantic Interpreter (*ASI*)**

A set of algorithms for deducing the semantic roles of arrow symbols in an arrow diagram, which is developed in this thesis.

### **Arrow Symbol**

A symbol with a linear part and a mark on it, which induces both linearity and asymmetry.

### **Association**

A semantic role of an arrow symbol to associate two different subjects, illustrating their asymmetric relation.

### **Behavioral description**

A semantic role of an arrow symbol to illustrate a spatial or temporal transition of a subject, possibly involving other entities on the course of transition.

### **Component**

An element in a diagram, such as an icon, a text label, a small diagram embedded in the diagram, or a specific position of a picture, a map, or an image, to which an arrow symbol refers. Components are categorized into primary components and modifier components.

### **Component Slot**

A conceptual area that may contain components, identified by an arrow symbol. Each arrow symbol identifies three component slots in front of, along, or behind the arrow symbol, which are called the tail slot, body slot, and head slot, respectively.

### **Direct Link**

A link between two arrow symbols established by their geometrical intersections.

### **Event ( $PC_E$ )**

A primary component that represents something that occurs in time and is characterized by a set of changes that it triggers.

### **Group Role**

The semantic role associated with a group of arrow symbols.

### **Indirect Link**

A link between two arrow symbols established when these arrow symbols refer to the same component.

### **Individual Role**

The semantic role associated with a single arrow symbol. This thesis distinguishes four types of individual roles: *orientation*, *behavioral description*, *annotation*, and *association*.

### **Individual Structure**

A model of the spatial arrangement of components referred by an arrow symbol, which is captured as a 3-tuple whose three elements are the respective component sets in the arrow symbol's three component slots.

### **Inter-Arrow Structure**

A model of the spatial arrangement of multiple arrow symbols, which is captured as the set of topological relations between all pairs of the arrow symbols.

### **Interpretation of an Arrow Symbol (or a Group of Arrow Symbols)**

The semantic role of an arrow symbol (or a group of arrow symbols) of arrow symbols deduced by people or a computer.

### **Link**

A spatial connection of multiple arrow symbols, usually representing certain relevance between the semantics associated with these arrow symbols. Links establish topological relations between arrow symbols. Direct links and Indirect links are distinguished.

### **Location ( $PC_L$ )**

A primary component that represents a position in space.

### **Modifier Component (MC)**

A component that modifies something else.

**Moment ( $PC_M$ )**

A primary component that represents a position in time.

**Multi-Arrow Diagram**

An arrow diagram that contains two or more arrow symbols.

**Nested Arrow Diagram**

A multi-arrow diagram that contains a subordinate arrow diagram.

**Object ( $PC_O$ )**

A primary component that represents an entity or its unit, which exists in physical or conceptual space and takes an action or gets manipulated.

**Orientation**

A semantic role of an arrow symbol, where the arrow symbol is attached to a subject, specifying its directional property.

**Pattern of an Individual Structure**

3-tuples, such as  $(MC, -, PC_L)$ , whose three elements show the types of all components in the arrow symbol's three component slots.

**Primary Component ( $PC$ )**

A component that represents an independent concept.

**Semantic Role**

The function of an arrow symbol or a group of arrow symbols to provide the information about the components to which the arrow symbol refers.

**Subordinate Arrow Diagram**

A sub-diagram of an arrow diagram which forms an arrow diagram by itself and is referred by an arrow symbol from outside.

## BIBLIOGRAPHY

- Agrawala, M. and Stolte, C. (2001) Rendering Effective Route Maps: Improving Usability through Generalization. in: Fiume, E. (Ed.) *28th Annual Conference on Computer Graphics and Interactive Techniques (SIGGRAPH 2001)*, Los Angeles, CA, 241-249, ACM Press.
- Alexandroff, P. (1961) *Elementary Concepts of Topology*. Dover, Mineola, NY.
- Allen, J. (1983) Maintaining Knowledge About Temporal Intervals. *Communications of the ACM*, 26(11): 832-843.
- Alvarado, C. and Davis, R. (2001a) Preserving the Freedom of Paper in a Computer-Based Sketch Tool. in: Smith, M., Koubek, R., Salvendy, G., and Harris, D. (Eds.) *HCI International*, New Orleans, LA, 687-691, Lawrence Erlbaum Associates.
- Alvarado, C. and Davis, R. (2001b) Resolving Ambiguities to Create a Natural Sketch Based Interface. in: Nebel, B. (Ed.) *17th International Joint Conference on Artificial Intelligence (IJCAI-01)*, Seattle, WA, 1365-1374, Morgan Kaufmann.
- Aoki, Y., Shio, A., Arai, H., and Odaka, K. (1996) A Prototype System for Interpreting Hand-Sketched Floor Plans. in: *International Conference on Pattern Recognition*, Vienna, Austria, 3, 747-751, IEEE Computer Society.
- Avila, V. (1992) *Biology: A Human Endeavor*. Bookmark Publishers, Chula Vista, CA.
- Bailey, T. and Gatrell, A. (1995) *Interactive Spatial Data Analysis*. Longman, Essex, UK.



- Becker, R., Eick, S., and Wilks, A. (1995) Visualizing Network Data. *IEEE Transactions on Visualization and Computer Graphics*, 1(1): 16-21.
- Bertin, J. (1983) *Semiology of Graphics: Diagrams, Networks, Maps*. University of Wisconsin Press, Madison, WI.
- Blaser, A. and Egenhofer, M. (2000) A Visual Tool for Querying Geographic Databases. in: Gesù, V., Levialdi, S., and Tarantini, L. (Eds.) *AVI2000 - Advanced Visual Databases*, Salerno, Italy, 211-216.
- Cheng, O., Lowe, R., and Scaife, M. (1999) Cognitive Science Approaches to Understanding Diagrammatic Representations. in: Blackwell, A. F. (Ed.) *Thinking with Diagrams*, Kluwer Academic Publishers.
- Chrisman, N. R. (1978) Concepts of Space as a Guide to Cartographic Data Structures. in: Dutton, G. (Ed.) *The First International Advanced Study Symposium on Topological Data Structures for Geographic Information Systems*, Cambridge, MA, 1-19, Harvard Laboratory for Computer Graphics and Spatial Analysis.
- Claramunt, C. and Theriault, M. (1995) Managing Time in GIS: An Event-Oriented Approach. in: Clifford, J. and Tuzhilin, A. (Eds.) *Recent Advances in Temporal Databases*, Zurich, Switzerland, 23-42, Springer.
- Claramunt, C., Theriault, M., and Parent, C. (1998) A Qualitative Representation of Evolving Spatial Entities in Two-Dimensional Topological Spaces. in: Carver, S. (Ed.) *Innovations in GIS V*. Taylor & Francis, 119-129.

- Clementini, E. and Di Felice, P. (1998) Topological Invariants for Lines. *IEEE Transactions on Knowledge and Data Engineering*, 10(1): 38-54.
- Clementini, E., Di Felice, P., and van Oosterom, P. (1993) A Small Set of Formal Topological Relationships Suitable for End-User Interaction. in: Abel, D. and Ooi, B. C. (Eds.) *3rd International Symposium on Advances in Spatial Databases*, Singapore, Lecture Notes in Computer Science, 692, 277-295, Springer.
- Cohen, P., McGee, D., and Clow, J. (2000) The Efficiency of Multimodal Interaction for a Map-Based Task. in: *6th Applied Natural Language Processing Conference (ANLP2000)*, Seattle, WA, 331-338, Morgan Kaufmann.
- Cohen, P. R., Johnston, M., McGee, D. R., Oviatt, S. L., Pittman, J. A., Chen, L., and Clow, J. (1997) QuickSet: Multimodal Interaction for Distributed Applications. in: *5th International Multimedia Conference (Multimedia '97)*, Seattle, WA, 31-40, ACM Press.
- Comins, N. and Kaufmann III, W. (2003) *Discovering the Universe*. W. H. Freeman and Company, New York, NY.
- Davis, R. (2002) Sketch Understanding in Design: Overview of Work at the MIT AI Lab. in: Davis, R., Landay, J., and Stahovich, T. (Eds.) *AAAI Spring Symposium on Sketch Understanding*, Stanford, CA, 24-31, AAAI Press.
- Do, E. and Gross, M. (2001) Thinking with Diagrams in Architectural Design. *Artificial Intelligence Review*, 15: 135-149.

- Egenhofer, M. (1989) A Formal Definition of Binary Topological Relationships. in: Litwin, W. and Schek, H.-J. (Eds.) *3rd International Conference on Foundations of Data Organization and Algorithms (FODO)*, Paris, France, Lecture Notes in Computer Science, 367, 457-472, Springer.
- Egenhofer, M. (1994) Definitions of Line-Line Relations for Geographic Databases. *IEEE Data Engineering Bulletin*, 16(3): 40-45.
- Egenhofer, M. (1996) Multi-Modal Spatial Querying. in: *7th International Symposium on Spatial Data Handling*, Delft, Netherlands, 785-799, Talyor & Francis.
- Egenhofer, M. (1997) Query Processing in Spatial-Query-by-Sketch. *Journal of Visual Languages and Computing*, 8(4): 403-424.
- Egenhofer, M. and Al-Taha, K. (1992) Reasoning About Gradual Changes of Topological Relationships. in: Frank, A., Campari, I., and Formentini, U. (Eds.) *Theories and methods of spatio-temporal reasoning in geographic space*, Pisa, Italy, Lecture Notes in Computer Science, 639, 196-219, Springer.
- Egenhofer, M. and Franzosa, R. (1991) Point-Set Topological Spatial Relations. *International Journal of Geographical Information Systems*, 5(2): 161-174.
- Egenhofer, M. and Franzosa, R. (1995) On the Equivalence of Topological Relations *International Journal of Geographical Information Systems*, 9(2): 133-152.

Egenhofer, M. and Herring, J. (1991) Categorizing Binary Topological Relationships between Regions, Lines and Points in Geographic Databases. in: Egenhofer, M., Herring, J., Smith, T., and Park, K. (Eds.) *A Framework for the Definitions of Topological Relationships and an Algebraic Approach to Spatial Reasoning within This Framework, NCGIA Technical Reports 91-7*. National Center for Geographic Information and Analysis, Santa Barbara, CA.

Egenhofer, M. and Mark, D. (1995) Modeling Conceptual Neighborhoods of Topological Line-Region Relations. *International Journal of Geographical Information Systems*, 9: 555-565.

Fellbaum, C., (Ed.) (1998) *WordNet: An Electronic Lexical Database*, Cambridge, MA, MIT Press.

Ferguson, R. and Forbus, K. (2000) GeoRep: A Flexible Tool for Spatial Representation of Line Drawings. in: *17th National Conference on Artificial Intelligence*, Austin, TX, 510-516, AAAI Press.

Ferguson, R. and Forbus, K. (2002) A Cognitive Approach to Sketch Understanding. in: Davis, R., Landay, J., and Stahovich, T. (Eds.) *AAAI Spring Symposium on Sketch Understanding*, Stanford, CA, 67-72, AAAI Press.

Ferguson, R., Rasch, R., Turmel, W., and Forbus, K. (2000) Qualitative Spatial Interpretation of Course-of-Action Diagrams. in: *Proceedings of the 14th International Workshop on Qualitative Reasoning*, Morelia, Mexico, 47-52.

- Fisher, R. A. (1922) On the Interpretation of  $\chi^2$  from Contingency Tables, and the Calculation of P. *Journal of the Royal Statistical Society*, 85(1): 87-94.
- Forbus, K., Ferguson, R., and Usher, J. (2001) Towards a Computational Model of Sketching. in: *6th International Conference on Intelligent User Interfaces*, Santa Fe, NM, 77-83, ACM Press.
- Forbus, K. and Usher, J. (2002) Sketching for Knowledge Capture: A Progress Report. in: *7th International Conference on Intelligent User Interfaces*, San Francisco, CA, 71-77, ACM Press.
- Freksa, C. (1992) Temporal Reasoning Based on Semi-Intervals. *Artificial Intelligence*, 54: 199-227.
- Funt, B. (1980) Problem-Solving with Diagrammatic Representations. *Artificial Intelligence*, 13: 201-230.
- Garcke, H., Preuber, T., Rumpf, M., Telea, A., Weikard, U., and van Wijk, J. (2000) A Continuous Clustering Method for Vector Fields. in: Hansen, C., Johnson, C., and Bryson, S. (Eds.) *Visualization 2000*, Los Alamitos, CA, 351-358, IEEE Computer Society Press.
- Gibson, J. (1979) *The Ecological Approach to Visual Perception*. Houghton Mifflin, Boston.

- Gombrich, E. (1990) Pictorial Instructions. in: Barlow, H., Blakemore, C., and Weston-Smith, M. (Eds.) *Images and Understanding: Thoughts About Images, Ideas About Understanding*. Cambridge University Press, Cambridge, UK, 26-45.
- Goyal, R. and Egenhofer, M. (2000) Consistent Queries over Cardinal Directions across Different Levels of Detail. in: Tjoa, A. M., Wagner, R., and Al-Zobaidie, A. (Eds.) *11th International Workshop on Database and Expert Systems Applications*, Greenwich, U.K., 876-880.
- Graedel, T. and Crutzen, P. (1995) *Atmosphere, Climate, and Change*. W. H. Freeman and Company, New York, NY.
- Guarino, N. (1998) Formal Ontology in Information Systems. in: Guarino, N. (Ed.) *FOIS'98*, Trento, Italy, 3-15, IOS Press.
- Gyori, G. (2002) Semantic Change and Cognition. *Cognitive Linguistics*, 13(2): 123-166.
- Hadzilacos, T. and Tryfona, N. (1992) Model for Expressing Topological Integrity Constraints in Geographic Databases. in: Frank, A., Campari, I., and Formentini, U. (Eds.) *The International Conference GIS—From Space to Territory: Theories and Methods of Spatio-Temporal Reasoning in Geographic Space*, New York, NY, Lecture Notes in Computer Science, 639, 252-268, Springer.
- Herring, J. (1991) The Mathematical Modeling of Spatial and Non-Spatial Information in Geographic Information Systems. in: Mark, D. and Frank, A. (Eds.) *Cognitive and Linguistic Aspects of Geographic Space*. Kluwer, Dordrecht, Netherlands, 313-350.

- Horn, R. (1998) *Visual Language: Global Communication for the 21st Century*. MacroVu, Inc., Bainbridge Island, WA.
- Hornsby, K. and Egenhofer, M. (1997) Qualitative Representation of Change. in: Hirtle, S. and Frank, A. (Eds.) *COSIT '97*, Laurel Highlands, PA, Lecture Notes in Computer Science, 1329, 15-33, Springer.
- Hornsby, K. and Egenhofer, M. (1998) Identity-Based Change Operations for Composite Objects. in: Poiker, T. and Chrisman, N. (Eds.) *8th International Symposium on Spatial Data Handling*, Vancouver, Canada, 202-213.
- Hornsby, K. and Egenhofer, M. (2000) Identity-Based Change: A Foundation for Spatio-Temporal Knowledge Representation. *International Journal of Geographical Information Science*, 14(3): 207-224.
- Hornsby, K., Egenhofer, M., and Hayes, P. (1999) Modeling Cyclic Change. in: Chen, P., Embley, D., Kouloumdjian, J., Liddle, S., and Roddick, J. (Eds.) *Advances in Conceptual Modeling*, Paris, France, Lecture Notes in Computer Science, 1227, 98-109, Springer.
- Johnson, M. (1987) *The Body in the Mind: The Bodily Basis of Meaning, Imagination, and Reason*. The University of Chicago Press, Chicago.

- Johnston, M. (1998) Unification-Based Multimodal Parsing. in: *17th International Conference on Computational Linguistics and 36th Annual Meeting of the Association for Computational Linguistics*, Montréal, Canada, 624-630, Morgan Kaufmann Publishers.
- Jones, C. (1997) *Geographical Information Systems and Computer Cartography*. Longman, Harlow, UK.
- Kovecses, Z. and Radden, G. (1998) Metonymy: Developing a Cognitive Linguistic View. *Cognitive Linguistics*, 9(1): 37-77.
- Kurata, Y. and Egenhofer, M. (2005a) Semantics of Simple Arrow Diagrams. in: Barkowsky, T., Freksa, C., Hegarty, M., and Lowe, R. (Eds.) *AAAI Spring Symposium on Reasoning with Mental and External Diagram: Computational Modeling and Spatial Assistance*, Stanford, CA, 101-104, AAAI Press.
- Kurata, Y. and Egenhofer, M. (2005b) Structure and Semantics of Arrow Diagrams. in: Cohn, A. and Mark, D. (Eds.) *COSIT '05*, Ellicottville, NY, Lecture Notes in Computer Science, 3693, 232-250, Springer.
- Kurata, Y. and Egenhofer, M. (2006a) The Head-Body-Tail Intersection for Spatial Relation between Directed Line Segments. in: *GIScience'06*, Münster, Germany, Lecture Notes in Computer Science, 4197, 269-286, Springer.



- Kurata, Y. and Egenhofer, M. (2006b) Ontology-Based Interpretation of Arrow Symbols for Visual Communication. in: Andrienko, G., Andrienko, N., Jankowski, P., and MacEachren, A. (Eds.) *GIScience 2006 Workshop on Visualization, Analytics & Spatial Decision Support*, Münster, Germany, CD-ROM.
- Kurata, Y. and Egenhofer, M. (2006c) Topological Relations of Arrow Symbols in Complex Diagrams. in: Barker-Plummer, D., Cox, R., and Swoboda, N. (Eds.) *Diagrams'06*, Stanford, CA, Lecture Notes in Artificial Intelligence, 4045, 112-126, Springer.
- Kurtoglu, T. and Stahovich, T. (2002) Interpreting Schematic Sketches Using Physical Reasoning. in: Davis, R., Landay, J., and Stahovich, T. (Eds.) *AAAI Spring Symposium on Sketch Understanding*, Stanford, CA, 78-85, AAAI Press.
- Lakoff, G. (1987) *Women, Fire, and Dangerous Things: What Categories Reveal About the Mind*. University of Chicago Press, Chicago, IL.
- Lakoff, G. and Johnson, M. (1980) *Metaphors We Live By*. University of Chicago Press, Chicago, IL.
- Landay, J. and Myers, B. (2001) Sketching Interfaces: Toward More Human Interface Design. *IEEE Computer*, 34(3): 56-64.
- Langacker, R. (1999) *Grammar and Conceptualization*. Mouton de Gruyter, Berlin, Germany / New York, NY.

- Larkin, J. and Simon, H. (1987) Why a Diagram Is (Sometimes) Worth Ten Thousand Words. *Cognitive Science*, 11(1): 65-99.
- Monmonier, M. (1990) Strategies for the Visualization of Geographic Time-Series Data. *Cartographica*, 27(1): 30-45.
- Moratz, R., Renz, J., and Wolter, D. (2000) Qualitative Spatial Reasoning About Line Segments. in: Horn, W. (Ed.) *14th European Conference on Artificial Intelligence*, Berlin, Germany, 234-238, IOS Press.
- Nedas, K., Egenhofer, M., and Wilmsen, D. (2007) Metric Details of Topological Line-Line Relations. *International Journal of Geographical Information Science*, 21(1): 21-48.
- Novak, G. (1995) Diagrams for Solving Physical Problems. in: Glasgow, J., Narayanan, N. H., and Chandrasekaran, B. (Eds.) *Diagrammatic Reasoning: Cognitive and Computational Perspective*. AAAI Press, Stanford, CA, 753-774.
- Oviatt, S. (1996) Multimodal Interfaces for Dynamic Interactive Maps. in: *Conference on Human Factors in Computing Systems (CHI '96)*, New York, NY, 95-102, ACM Press.
- Oviatt, S. (1999) Mutual Disambiguation of Recognition Errors in a Multimodal Architecture. in: *Conference on Human Factors in Computing Systems (CHI '99)*, Pittsburgh, PA, 576-583, AAAI Press.

- Oviatt, S. and Cohen, P. (2000) Multimodal Interfaces That Process What Comes Naturally. *Communications of the ACM*, 43(3): 45-53.
- Peuquet, D. (1984) A Conceptual Framework and Comparison of Spatial Data Models. *Cartographica*, 21(4): 66-113.
- Pinker, S. (1990) A Theory of Graph Comprehension. in: Freedle, R. (Ed.) *Artificial Intelligence and the Future of Testing*. Lawrence Erlbaum, 73-126.
- Pullar, D. and Egenhofer, M. (1988) Towards Formal Definitions of Topological Relations among Spatial Objects. in: *3rd International Symposium on Spatial Data Handling*, Sydney, Australia, 225-241.
- Reiter, R. (1987) On Closed World Data Bases. in: Gallaire, H. and Minker, J. (Eds.) *Logic and Data Bases*. Plenum Press, New York, NY, 55-76.
- Renz, J. (2001) A Spatial Odyssey of the Interval Algebra: 1. Directed Intervals. in: Nebel, B. (Ed.) *International Joint Conference on Artificial Intelligence 2001*, Seattle, WA, 51-56, Morgan Kaufmann.
- Retz-Schmidt, G. (1988) Various Views on Spatial Prepositions. *AI Magazine*, 9(2): 95-105.
- Robinson, A., Morrison, J., Muehrcke, P., Kimerling, A., and Guptill, S. (1995) *Elements of Cartography*. John Wiley & Sons Inc., New York, NY.
- Sagan, C. and Sagan, L. (1972) A Message from Earth. *Science*, 175(4024): 881-884.

- Sanna, A., Montrucchio, B., and Montuschi, P. (2000) A Survey on Visualization of Vector Fields by Texture-Based Methods. *Research Developments in Pattern Recognition*, 1(1): 13-27.
- Schlaisich, I. and Egenhofer, M. (2001) Multimodal Spatial Querying: What People Sketch and Talk About. in: *1st International Conference on Universal Access in Human-Computer Interaction*, New Orleans, LA, 732-736.
- Schlieder, C. (1995) Reasoning About Ordering. in: Frank, A. and Kuhn, W. (Eds.) *COSIT '95*, Lecture Notes in Computer Science, 988, 341-349, Springer.
- Seto, K. (1999) Distinguishing Metonymy from Synecdoche. in: Panther, K.-U. and Radden, G. (Eds.) *Metonymy in Language and Thought*. John Benjamins, Amsterdam, Netherland, 91-120.
- Skubic, M., Blisard, S., Carle, A., and Matsakis, P. (2002) Hand-Drawn Maps for Robot Navigation. in: Davis, R., Landay, J., and Stahovich, T. (Eds.) *AAAI Spring Symposium Technical Report*, Stanford, CA, 140-147, AAAI Press.
- Stahovich, T. (1997) Interpreting the Engineer's Sketch: A Picture Is Worth a Thousand Constraints. in: Anderson, M. (Ed.) *AAAI Fall Symposium on Reasoning with diagrammatic Representations II*, Stanford, CA, 31-38, AAAI Press.
- Stenning, K. and Oberlander, J. (1995) A Cognitive Theory of Graphical and Linguistic Reasoning: Logic and Implementation. *Cognitive Science*, 19(1): 97-140.

- Tobler, W. (1981) Depicting Federal Fiscal Transfers. *Professional Geographer*, 33(4): 419-422.
- Tobler, W. (1987) Experiments in Migration Mapping by Computer. *The American Cartographer*, 14(2): 155-163.
- Tufte, E. (1990) *Envisioning Information*. Graphics Press, Cheshire, CT.
- Tversky, B. (2000) Some Ways That Maps and Diagrams Communicate. in: Freksa, C., Brauer, W., Habel, C., and Wender, K. (Eds.) *Spatial Cognition II: Integrating Abstract Theories, Empirical Studies, Formal Methods, and Practical Applications*, Lecture Notes in Computer Science, 1849, 72-79, Springer.
- Tversky, B. (2001) Spatial Schemas in Depictions. in: Gattis, M. (Ed.) *Spatial Schemas and Abstract Thought*. MIT Press, Cambridge, MA, 79-111.
- Tversky, B., Heiser, J., Lozano, S., Mackenzie, R., and Morrison, J. (2007) Enriching Animations. in: Lowe, R. and Schnotz, W. (Eds.) *Learning with Animation: Research and Implications for Design*. Cambridge University Press, Cambridge, UK.
- Tversky, B. and Lee, P. (1999) Pictorial and Verbal Tools for Conveying Route. in: Freksa, C. and Mark, D. (Eds.) *Spatial Information Theory, COSIT '99*, Stade, Germany, Lecture Note in Computer Science, 1661, 51-64, Springer.

- Tversky, B., Zacks, J., Lee, P., and Heiser, J. (2000) Lines, Blobs, Crosses and Arrows: Diagrammatic Communication with Schematic Figures. in: Anderson, M., Cheng, P., and Haarslev, V. (Eds.) *Theory and Application of Diagrams (Diagrams 2000)*, Edinburgh, UK, Lecture Notes in Artificial Intelligence, 1889, 221-230, Springer.
- Van der Waarde, K. and Westendorp, P. (2000) The Functions of Arrows in User Instructions. in: *The IIID Expert Forum on Manual Design*, Eskilstuna, Sweden.
- Westendorp, P. (2006) Design & Evolution of the Symbolic Arrow. in: *Design & Evolution Conference*, Delft, Netherlands, Design History Society.
- Wildbur, P. and Burke, M. (1998) *Information Graphics: Innovative Solutions in Contemporary Design*. Thames & Hudson, New York, NY.
- Worboys, M. and Duckham, M. (2004) *GIS: A Computing Perspective*. CRC Press, Boca Raton, FL.
- Worboys, M. and Hornsby, K. (2004) From Objects to Events: GEM, the Geospatial Event Model. in: *GIScience 2005*.

## BIOGRAPHY OF THE AUTHOR

Yohei Kurata was born in Yokohama, Japan, on December 28, 1977. He studied at the University of Tokyo with a major of city planning and obtained a *Gakushi-Kogaku* (Bachelor of Engineering) in Urban Engineering from the University of Tokyo in 2000. Around that time he developed his interest in spatial information systems, especially those for ordinary people, and wrote a bachelor's thesis entitled "*Development of a Preference-Based Tour Planning System.*" He then began his master's study in the Department of Urban Engineering and obtained a *Shushi-Kogaku* (Master of Engineering) in Urban Engineering from the University of Tokyo in 2002. His master's thesis, entitled "*Methods for Modeling and Automatic Matching of Rough Maps,*" evoked his interest in sketching interfaces of spatial information systems. After attending the doctoral course at the University of Tokyo for one semester, he moved to the University of Maine in 2002, where he began his doctoral study in spatial information science and engineering. Since 2005 he has served as a Graduate Research Assistant with the National Center for Geographic Information and Analysis and was awarded the College of Engineering's Graduate Research Assistant Award in 2006. As the first author he has published five papers in referred conference proceedings and one paper in Japanese research journal.

Yohei Kurata is a candidate for the Doctor of Philosophy degree in Spatial Information Science and Engineering from the University of Maine in May, 2007.